

DentalDeal

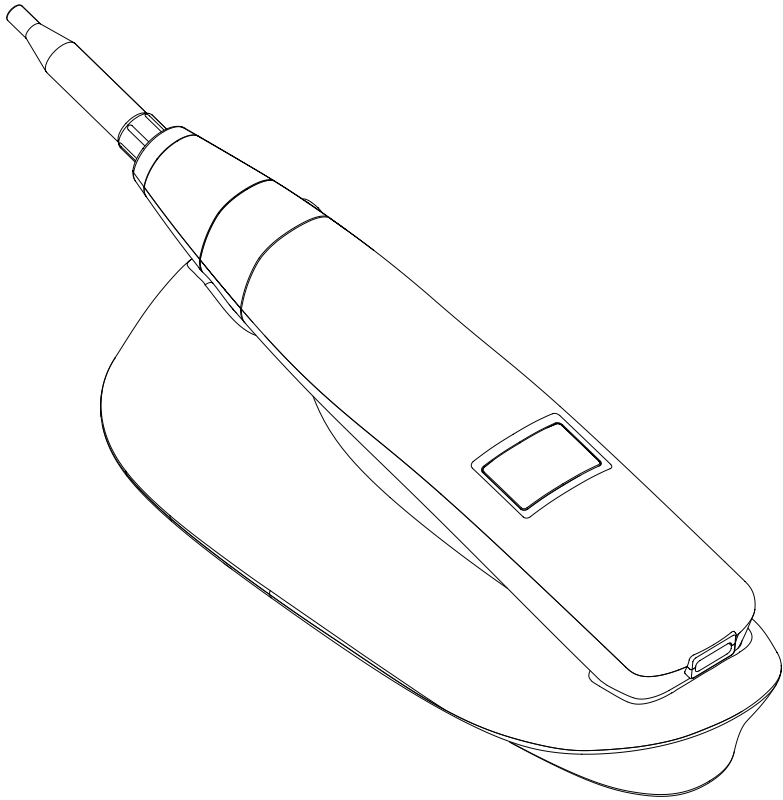

Implant Stability Meter

Instruction Manual

Please read this manual before operating

Contents

1. Intended use
2. Characteristics
3. Components
4. Technical Specifications
5. Performance
8. Operation Method
6. Symbols
7. Preparation Before Use
8. Workflow Diagram
9. Operation Method
10. Measuring Process
11. Checking Measured Value (iST scale)
12. Product Performance Test
13. Precautions During Use
14. Charging Battery
15. Assembling/Disassembling Method
16. Cleaning After Use
17. Strilization After cleaning
18. Storage after sterilization

1. Intended use

It is a stability measuring device that uses tapping method, which measures the time of the Tapping Rod of the device contacting the implant for dentistry and dental implantology or oral cavity, or abutment, to measure the stability of the placed implant. The result of the measurement is displayed in iST scale (implant Stability Test), which is the numerical representation of the Implant Stability Test (iST) value, and higher scale represents greater implant stability or lower implant mobility. And the intended user is dentist and dental nurse.

2. Characteristics

- ① Convenient usage due to small and light design
- ② Easy to use due to simple controlling method
- ③ Fast measuring time less than 3 seconds
- ④ Safe measurement due to slight tapping technique and auto safety system (tapping stops after tapping twice when Osseointegration is unstable, otherwise taps up to 6 times.)
- ⑤ Available to check possibility of implant failure at in earlier stages.

3. Components

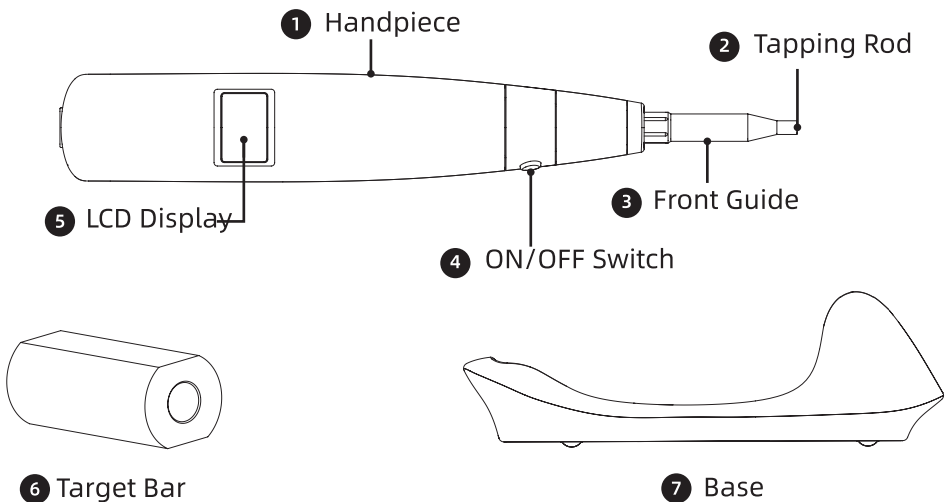

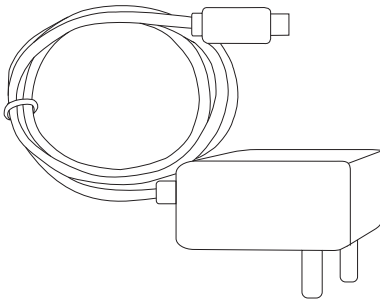

9 Adapter

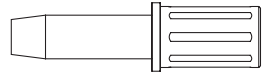

8 Allen Wrench

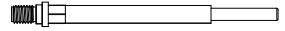

11 Tapping Rod

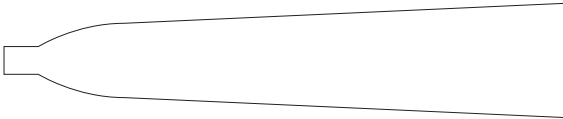

12 Disposable Sleeves

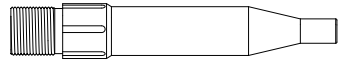

12 Front Guide

NO.	Classification	Description
1	Handpiece	Main Body of Handpiece
2	Tapping Rod (Applied Part)	A Tapping Rod which taps Abutment of an implant to measure implant stability and degree of Osseointegration.
3	Front Guide	Front Guide of a Tapping Rod is where the Tapping Rod contacts abutment and guides the movement of the Tapping Rod.
4	Switch	Multi-functioning Switch button that turns the device on and off and operates the tapping-motion. To turn on and off the device, press and hold the button for a while. Press the button once shortly to operate the tapping-motion.
5	LCD Display	Display function:ON / OFF display, Operation display (Check/ Ready), Charging display (Charging/Charged), iST scale display (1~99), Error display (Error) *iST scale represents the degree of implant stability

NO.	Classification	Description
6	Target Bar	Target Bar is a testing device that tests precision of measuring value. After connecting with the handpiece, measuring within a range of 0 ~ 30 degree is required and the number of measuring value should be in a range of ± 3 from the standard value.
7	Base	It is the place to mount the handpiece when not in use.
8	Allen Wrench	Allen Wrench is a Wrench designed for connecting and disconnecting the Tapping Rod from the main body. While connecting and disconnecting the Tapping Rod, the Wrench enables both screwing and loosening the Rod from the main body.
9	Adapter	USB Type C cable is used for charging the device by connecting the cable to the handpiece of the device.
10	Disposable Sleeves	The disposable sleeves are single patient use only. Discard used disposable sleeves in standard waste after each patient.
11	Tapping Rod	For replacement use during disinfection
12	Front Guide	

4. Technical Specifications

- ① Protection type against electrical shock: Class II
- ② Protection degree against electrical shock: Type B
- ③ Rechargeable lithium battery:
Battery model:16340, Battery capacity: 850mAh
Battery has over-voltage, over current and short circuit protection
- ④ Adapter
Input:100-240V~50/60Hz
Output: 5V  1A

⑤ Work condition:Environment temperature: +5°C to +40°C

Relative humidity: 10%~93%

Atmosphere pressure: 70kPa to 106kPa

⑥Operation Mode : Continuous Operation

5. Performance

①Accuracy : Display value ± 3





②Tapping Speed : 0.5 sec./ 1 time

















③Tapping Strength: ≤ 1.0 N to 1.3 N

④Number of Tapping :Taps 2~4 times until the measured value of 1~59.
After 60 ~ 99, the device taps 6 times in order to measure the stability.

6. Symbols

①Safety Sign: Symbol for safety sign is displayed on exterior of the device, on package design, and on user manual. Symbol delivers important notification and caution to users. Symbols displayed below must be carefully read and followed by users prior to using the device for proper use and management.

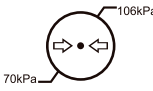
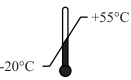
	Warning	This Warning sign warns users that the use of damaged product may cause irreversible damage to patients.
	Caution	This Caution sign is related to possibilities of damaging product or harming patients.
	Prohibition	This Prohibition sign is related to possibilities of amaging product or harming patient
	Mandatory-user Action	This Mandatory Action sign means "refer to the user manual."

Symbol	Symbol description	Symbol	Symbol description
	Check the random file		Appliance compliance WEEE directive
	Refer to the user manual		Power on, Power off, Start tapping-motion
	Type B applied part	IPX0	Ordinary equipment
	Date of manufacture		Manufacturer
	Class II equipment		Used indoor only
	Direct current		Alternating current
	Fear of rain		Recyclables
	Fragile items		Atmospheric pressure for storage storage
	Temperature limitation for storage storage		Humidity limitation for storage storage

7. Preparation Before Use

- ① Charge at minimum 3 hours before the first use. (Battery is re-chargeable)
- ② The hadpiece of the device and the Tapping Rod must be disconnected and sterilized prior to usage. (Refer to the context below for Tapping Rod removal manual and Sterilization

8. Workflow Diagram

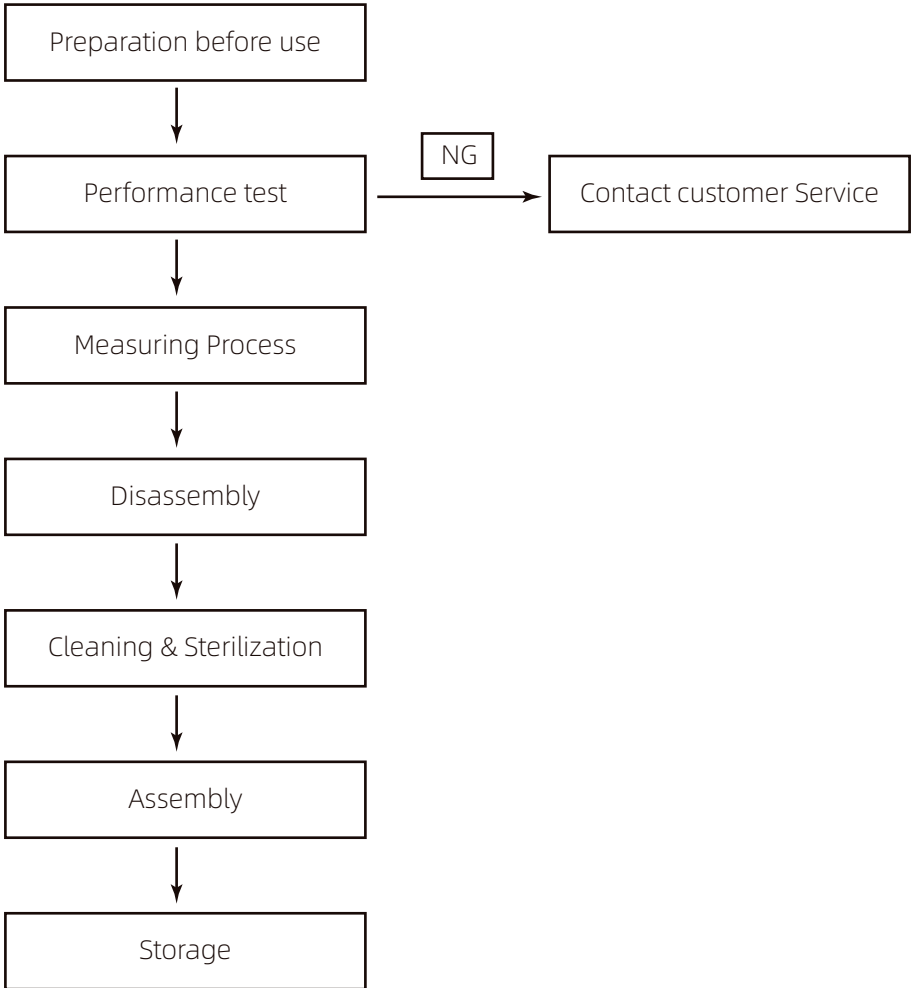

9. Operation Method

① Power ON

When the device is OFF, press the ON/OFF button once to turn on the LCD display and goes to Ready mode. (Ready mode is measuring mode).

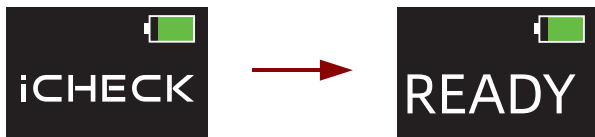

②Action

When power is ON (Ready mode), shortly press the ON/OFF button to start. The device will make a short beeping sound and the tapping-motion will start operating immediately. The measured value will be displayed on the LCD Display as shown below.

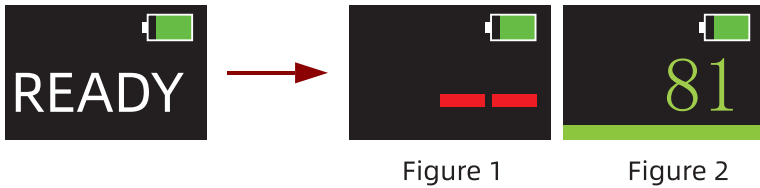

Figure 1

Figure 2

③Power OFF

- Hold the ON/OFF button for a while until the device turns off while making a short beeping sound
- If the device is not used for 2 minutes, it automatically turns off.

④. Numbers displayed on the LCD screen

- The larger number on the right of the reading shown in Figure 2 is the current reading, and the smaller number on the left is the last reading.
- The reading in Figure 1 is displayed as two red bars, indicating that the handpiece has no reading or data error.

10. Measuring Process

- ①Take out the disposable sleeve and put it on the handpiece before use.
- ②Turn the power on by pressing the ON/OFF switch.
- ③Carefully position the tip of the Tapping Rod to the upper edge of the healing abutment while being cautious not to push the abutment.
- ④Maintain the contact angle within the range of $0^{\circ} \sim 30^{\circ}$ to upward

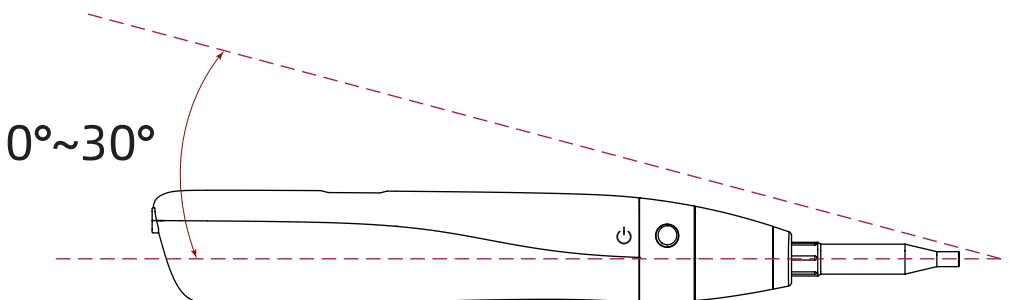

④When the Tapping Rod of the handpiece is located 90 degree from the side part of the top of the healing abutment and the ON/OFF switch is pressed once, the tapping motion starts after 0.5 second.

⑤The measured value is more accurate when the degree between the healing abutment and the Front Guide is closer to perpendicular.

⑥Check the numbers displayed on the LCD screen of the device.

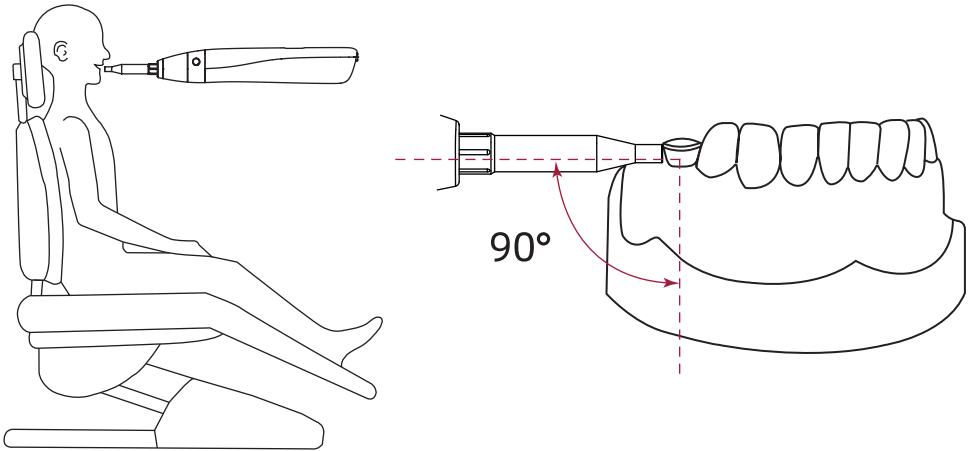

⑦Due to the different bone widths in different directions of the implant, the measurement data will be biased. Try to measure the stability value from multiple angles to get a reasonable value.





- ① If the contact angle is off the range ($0^{\circ} \sim 30^{\circ}$, upward from the surface), an alert sound will be on and the LCD screen displays "TOO LOW" or "TOO HIGH", the handpiece will not operate. In this case, tilt the device until the contact angle is back in the range; and then, try measuring again.
- ② Measurement error may occur if the tip of the Front Guide applies too much force to the healing abutment or is too far away from the healing abutment during measurement.
- ③ Empty tapping-motion results in no reading or obvious data errors.

11. Checking Measured Value (iST scale)



Measured value is similar to ISQ scale:

- above 60: bridge recommended;
 - above 70: single case loading possible.
- ① A range of measured value is displayed as a number between 01 to 99.
 - ② Color of the number appears as **Red (1 to 59)**, **Yellow (60 to 64)**, **Green(65 to 99)**.
 - ③ Green light below the LCD Display is the status bar.



- ④ Lower the measured value (iST scale), greater the implant mobility (weaker the degree of osseointegration).
- ⑤ The measured values differ depending on the height of the healing abutment. Calculate the correct iST scale as shown on the chart below: the standard height of the healing abutment is set as 4mm, and iST scale changes as the height of the healing abutment changes.

Standard+3	Height 7mm Healing Abutment	Actual Value=Displayed IST scale +6
Standard+2	Height 6mm Healing Abutment	Actual Value=Displayed IST scale +4
Standard+1	Height 5mm Healing Abutment	Actual Value=Displayed IST scale +2
Standard	Height 4mm Healing Abutment	Actual Value=Displayed IST scale
Standard-1	Height 3mm Healing Abutment	Actual Value=Displayed IST scale -2
Standard-2	Height 2mm Healing Abutment	Actual Value=Displayed IST scale -4
Standard-3	Height 1mm Healing Abutment	Actual Value=Displayed IST scale -6

12. Product Performance Test

① Install the target bar to the Tapping Rod as shown on the picture below.

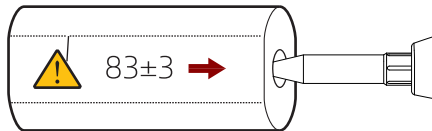

② After installation, measure the iST scale by pressing the switch shortly while adjusting the angle of the device into the range of upward 0° ~ 30°.

* Error notification sound beeps when the device is trying to measure from outside of the range.

③ The device is functioning well if measured value on the LCD Display is (±3) from the standard value.

* Standard value means the value written at the target bar, which is shown as same as the example below.

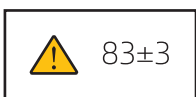

④ The standard value is based on the label on the Target Bar.

⑤ Please contact our customer service center if the displayed standard value shows a higher difference than (± 3) standard value more than 3 times.

13. Precautions During Use

- ① Understand the appropriate use of the product and be completely aware of the precautions prior to using the product.
- ② Do not disassemble or modify the device arbitrarily.
- ③ Do not use this product for uses other than as indicated herein.
- ④ Use at an appropriate environment within a dental clinic or hospital.
- ⑥ Use under control of a professional doctor while the patient is sitting still on the dental chair.

14. Charging Battery

- ① Connect the USB Type C cable, which is connected to the 5V adapter charger.
- ② "Charging" shows up on the LCD Display while battery is charging.
- ③ "Charged" is displayed on the LCD Display when the device is fully charged.
- ④ Charging time takes approximately 3 hours depending on circumstances.
- ⑤ When the battery is fully charged, the device is capable of measuring approximately 4000 times.
- ⑥ When the battery icon on the screen is red, it indicates that the battery is used up. In this case, the device automatically does not action tapping-motion, please charge in time.

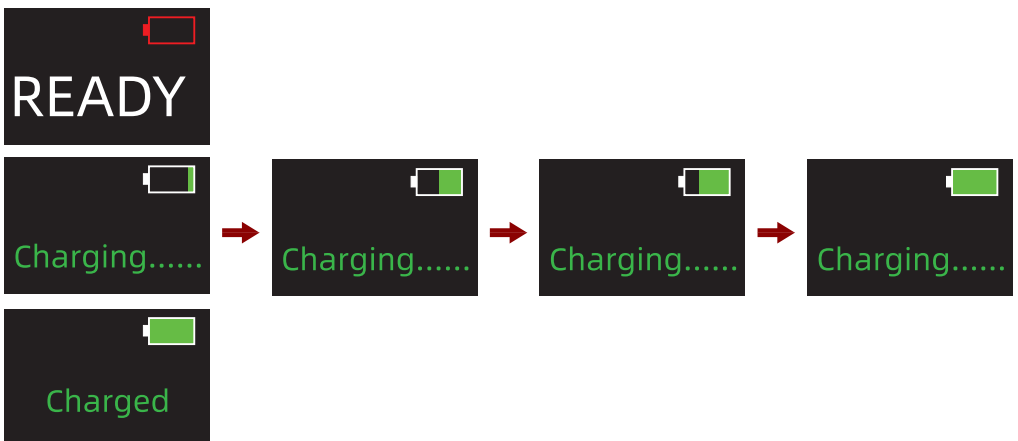



- Use only with adapter provided by manufacturer.
- Using adapters from other brands may cause a fire, explosion, or a damage to the product.
- The device is unable to use while charging.
- If the battery drains abnormally quickly, it indicates that the battery life is almost over. In this case, please contact our customer service for a battery exchange.
- When battery leakage occurs, stop using the device and call our customer service.

15. Assembling/Disassembling Method

① Disassemble the Front Guide from the Tapping Rod by turning the Front Guide counterclockwise as displayed below.

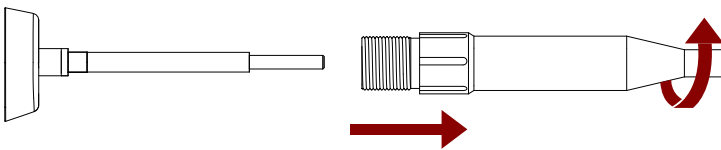

② Connect the Allen Wrench to the Tapping Rod as displayed below.

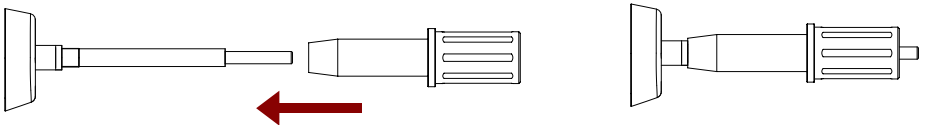

③ Disassemble the Tapping Rod-1 from the Tapping Rod-2 by turning the Allen Wrench counterclockwise by hand as displayed below.

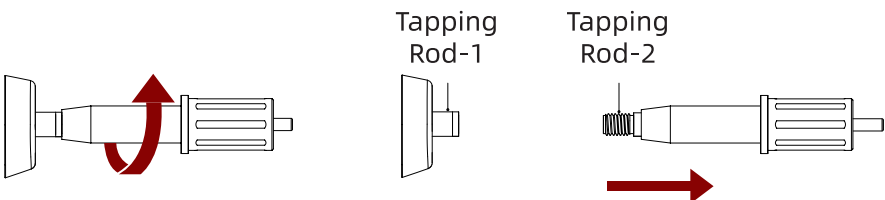

④ For assembling the Tapping Rod, connect each parts of disassembled Tapping Rod on a reverse order.

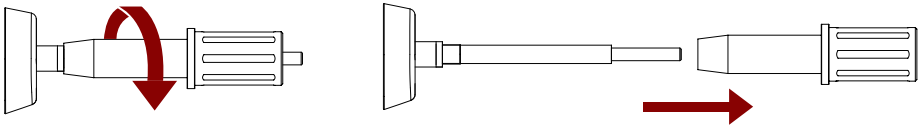

⑤ Hold the Front Guide and connect it to the external metal tube by turning clockwise. Tighten the connection without any gap as displayed below.

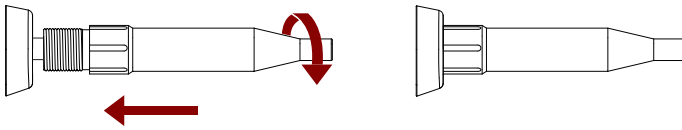

16. Cleaning After Use

① Immediately remove the Tapping Rod, Front Guide and Front Guide according to the disassembling method and Immerse in ethyl alcohol (75%) and use a brush to remove foreign matter or blood.

② Rinse the alcohol-washed part first with water. Remove any traces of blood or foreign objects remaining. Use a syringe or pipe cleaner for areas that are difficult to wash.

③ Final wash with flowing purified water for at least 1 minute.

④ Wipe it with a dry cloth or remove the water completely with warm-air circulator.(60°C, 30 min).

⑤ If the surface of the body is to be cleaned, it can be wiped with a cloth soaked with water.



- Do not use disinfection sprays. It is very important to avoid the disinfection fluid penetrate into the inner parts of the product.
- Never use oil or lubricants.



17. Strilization After cleaning

- ① In high steam sterilization (autoclave), pre-vacuum can be selected. (Only the separated "Tapping rod", "Front Guide" and "Allen Wrench" are sterilized and reusable)
- ② The end user is to use a FDA cleared wrap for the parameter.
- ③ Sterilization condition is same below.

Cycle Type	Temperature	Pressure	Exposure Time	DryTime
PreVacuum	135°C	0.22Mpa	4 minutes	30 minutes



- The sterilization temperature should not exceed 135°C (275 °F)
- Remove from autoclave immediately after finished cycle.
- Allow to cool down before use; handle carefully when hot.
- Do not wash in dishwasher.
- Do not use other cleaning fluids as they can damage the top cover of the instrument.
- Instruments are reusable for sterilization. We guarantee our products to withstand a minimum of two hundreds (200) sterilization cycles when sterilized according to the criteria listed.

18. Storage after sterilization

- ① The sterilized tapping rod must be reassembled into the handpiece.
- ② Store in a safe place to protect against water, vibration, external shock or damages.
- ③ Store away from direct sunlight.