

Bone Surgery and Implantation machine All In One

XLY-ZZJ300 (Read the instruction carefully before use)



Contents I for Implant Machine

1. Attention Points	1
1.1 Signs	1
1.2 Safety warning signs and instructions	1
1.3 Safety Tips	2
1.4 Electromagnetic compatibility explanation	2
2. Expected use	3
3.contraindication	3
4.device structure	3
4.1 Front of device	3
4.2 Back of device	4
4.3 Wireless Pedal	4
4.4 Motor handle	4
4.5 Bone knife handle	5
5.Installation	5
5.1 Install install support rod	5
5.2 Insert the wireless pedal	6
5.3 Connect motor and bone knife	6
5.4 Install straight handpiece or contra angle handpiece	6
5.5 Dismantle contra angle handpiece	7
5.6 Connect Cooling Liquid container and tube set	7
5.7 Connect power	8
6. Use	9
6.1 The prepare of operation	9
6.2 Programs	10
6.3 Setting	12
6.4 Change defaults	14
6.5 Function	16
6.6 Restore the factory settings	19
6.7 Calibration motor	20
7. Maintenance	20
7.1 Replace fuse	20
7.2 Replace LED	21
7.3 Replace o- ring	22
8. Recycling and disposal of waste	24
9. Cleaning, disinfection, and sterilization	24
9.1 Cleaning	24
9.2 Disinfection	24
9.3 Automatic hot cleaning and disinfection	24
9.4 Drying	25
9.5 Package	25
9.6 Sterilization	26
9.7 Storage	26
10. After-sale service	26
10.1 Quality assurance	26
10.2 Disclaimer	27
11. Running Environment,transport and storage conditions	27
11.1 Running Environment	27
11.2 Transport and storage conditions	27
12. The content of standard packing	28



















Machine

1.Product Introduction	29
1.1 Foreword-	29
1.2 Product contraindications and precautions-	29
1.3 Scope of Application	30
1.4 The performance structure and composition of product-	31
1.5 Safety requirements-	31
1.6 The basic principles of product	31
2.Product Nameplate	31
2.1The description of Nameplate	31
2.2 Equipment parameter nameplate	31
2.3 Handle parameter nameplate-	31
2.4 Foot pedals parameter nameplate	31
3.Testing of equipment-	32
4.Transport	32
5.Accessories description	32
6.Installation	32
6.1Safety requirements during installation-	32
6.2 Initial installation-	33
6.3 Connect attachments-	33
7.Use	34
7.1 Panel control	35
7.4 System protection and warnings-	36
7.5 Instructions for use	37
7.6 Requirements for keeping the equipment in normal operation-	39
8.Cleaning, disinfection and sterilization	39
8.1Cleaning, disinfection and sterilization-	39
8.2 Cleaning and disinfection equipment surface-	39
8.3 Sterilization process-	40
8.4 High temperature and high pressure steam sterilization of the handle-	40
8.5 High temperature and high pressure steam sterilization of working tips	41
8.6 High-temperature and high-pressure steam sterilization of force-limiting wrenches	41
8.7 High-temperature and high-pressure steam sterilization of pump tubes-	41
8.8High-temperature and high-pressure steam sterilization of pump tube connectors	41
8.9 High-temperature and high-pressure sterilization of the handle bracket	41
9.Storage and maintenance	42
10.Fuse Replacement-	42
11.Disposal procedures and precautions	42
12.Working tip-	43
12.1 Sharp working tips	43
12.2 Smooth working tip	43
12.3 Blunt working tips-	43
13. Electromagnetic Compatibility description-	44
13.1 Electromagnetic Compatibility-	44
13.2 The statement of Guide and manufacturer-electromagnetic emission	45
13.3 The statement of Guide and manufacturer-electromagnetic immunity-	46
13.4 The statement of Guide and manufacturer-electromagnetic immunity-	47
13.5 Recommended separation distances between portable and mobile RF communications equipment and this equipment	47

1. Attention Points

Please read this manual carefully before using, maintaining, and keep it for reference. Our company reserves the right to update and upgrade this manual and the products described herein without notice. The service life of this device is 10 years, and the manufacturing date see the product batch number.

1.1 Signs

	See “Safety Warning Signs and Instructions”		Operator and Maintainer need to know these information.
	Please refer to the manual		Waterproof grade
	Can thermal disinfection		Sterilizable at 134 °C
	B-type application part		temperature limits (5°C-40°C)
	Air humidity limit		Atmospheric pressure limit
	Avoid sun-baked		Keep dry
	Forward place		Fragile handle with care
	Stacking layer limit label		WE EE recycling label
	Sequence No.		Batch code
			Classification No.

1.2 Safety warning signs and instructions

<p>Attention ! It could lead to the risks of property loss or minor and moderate injuries.</p>
<p>Warning ! It could lead to the risks of serious injuries and died of the wounds.</p>
<p>Danger ! It could directly lead to the risks of serious injuries and death.</p>

1.3 Safety tips

Warning!

Use the unauthorized parts or change the product without permission will lead to injuries and Material loss risks.

- ▶ Please only use the matching parts in manufacturer's permission.
- ▶ Product reformation must be in manufacturer's permission .

Attention !

The product produce electricity spark will lead to explosion or fire risk.

- ▶ Don't operate the product in areas with a risk of explosion.
- ▶ Don't operate the product in an oxygen-rich environment.

Attention !

The damaged power cord/no earth wire may cause electric shock.

- ▶ Please check the power cord before use. The socket must be equipped with protective contacts and accord with correlation regulations in each country.



Attention !

Liquid permeates may cause electronic components to malfunction.

- ▶ Prevent liquid from penetrating through the product opening position.



Attention !

Unexpected Liquid permeates may cause the risk of electric shock. Don't operate the product in areas with a risk of explosion.

- ▶ Please check and ensure the sealing of coolant container and pipeline. If there is liquid on the device, do not touch the device, directly disconnect the power cord from power grid, and then reinsert the power cord after ensure the surface of device is completely dry.



Attention !

It may cause injuries when the pump work with parts rotated.

- ▶ Please turn off the device when the pump is on, and don't touch rotating parts with hand.



Attention !

Electromagnetic fields can affect the function of implanted systems such as heart pacemakers.

- ▶ Before the treatment, ask the patient if they have a pacemaker or other implanted system!



Attention !

Power cut or other faults may cause the motor handle to stop.

- ▶ Please ensure the power supply.

1.4 Electromagnetic compatibility explanation

! Tips !

According to the requirements of the electromagnetic compatibility standard for medical electronic equipment, please observe the following precautions:

- ▶ Medical electronic equipment must have special precautions for electromagnetic compatibility, and install and operate the device according to the requirements of the manufacturing installation guide.
- ▶ High-frequency communication equipment may affect medical electronic equipment.

! Tips !

The manufacturer cannot guarantee the relevant standards for these accessories, wires and other components not delivered by the manufacturer.

2. Expected Use

Suitable for dental implant surgery.

3. Contraindication

Systemic diseases (tumors, serious cardiovascular diseases, blood system diseases, immune disorders, ...).

Some systemic and topical therapy are doing (anti-coagulation therapy, chemotherapy, radiotherapy, ...). The bone with poor quality.

4. Device Structure

4.1 Front of device

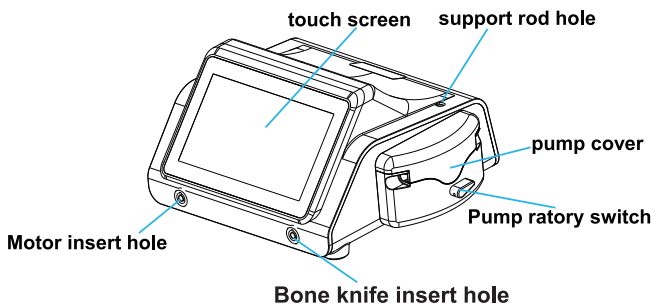

4.2 Back of device

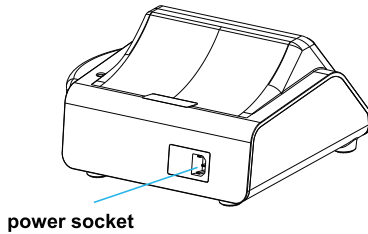

4.3 Wireless Pedal

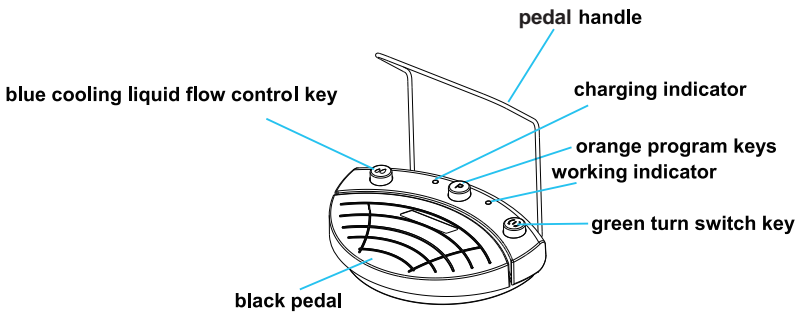

4.4 Motor handle

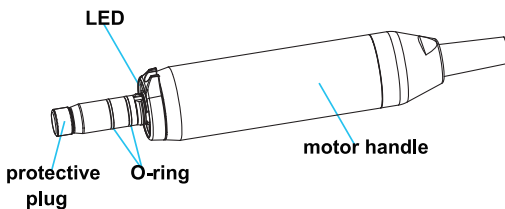

5.Installation

Tips !

Except for the cooling liquid delivery hose kit,the rest parts are not sterilized when out of factory.
The motor handle must be sterilized before the first treatment.

5.1 Install support rod

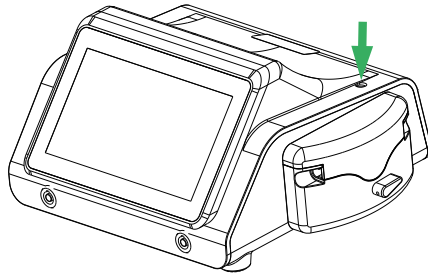

► Insert the support rod into the support rod hole on the device.

5.2 Insert the wireless pedal

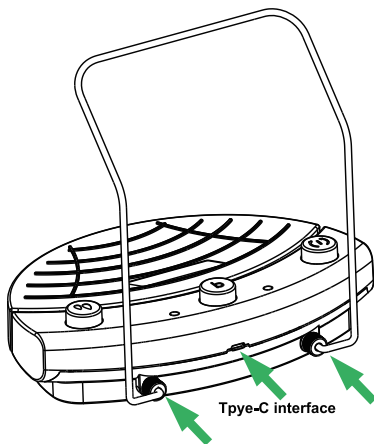

► Insert the pedal handle into the groove of the pedal and then tighten the nut manually.

5.3 Connect motor and bone knife

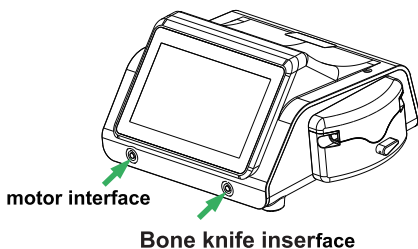

► Insert the motor plug into motor interface of the device, align the marking points and insert the plug until it locks.

.....

5.4 Install straight handpiece or contra angle handpiece

⚠ Attention !

Replacing the handpiece during operation will cause serious wear on the motor and handpiece.

- ▶ The handpiece can only be replaced when the motor is stopped;
- ▶ The motor can be adapted to all types handpiece that meet the YY1012 standard.

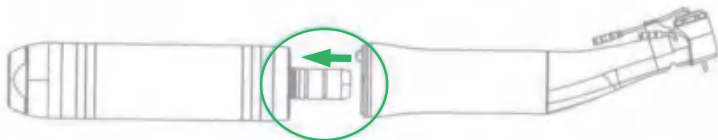

- ▶ Align the upper pillar of the handpiece with the slot of the motor, and insert the head until we hear a "click": turn the handpiece.
- ▶ Check the handpiece whether firmly on the motor or not. Don't operate the product in an oxygen-rich environment.

5.5 Dismantle contra angle handpiece

⚠ Attention !

Replacing the handpiece during operation will cause serious wear on the motor and handpiece.

- ▶ The handpiece can only be replaced when the motor is stopped.

- ▶ Pull the cooling liquid hose out of the handpiece;
- ▶ Gently pull out the handpiece.

5.6 Connect Cooling Liquid container and tube set

⚠ Attention !

The pump roller may cause injury risk during operation.

- ▶ Please turn off the device before opening the pump roller.

⚠ Attention !

Risk of tipping over due to excessive weight of cooling liquid container.

- ▶ Use a cooling liquid container with a maximum capacity of 1 litre and check the stability of the container.

Tips !

The sterilized hose kit must be replaced after each use.

Tips !

Please check that hose kit is in good condition before use. If the product or packaging is damaged, the product must be disposed.

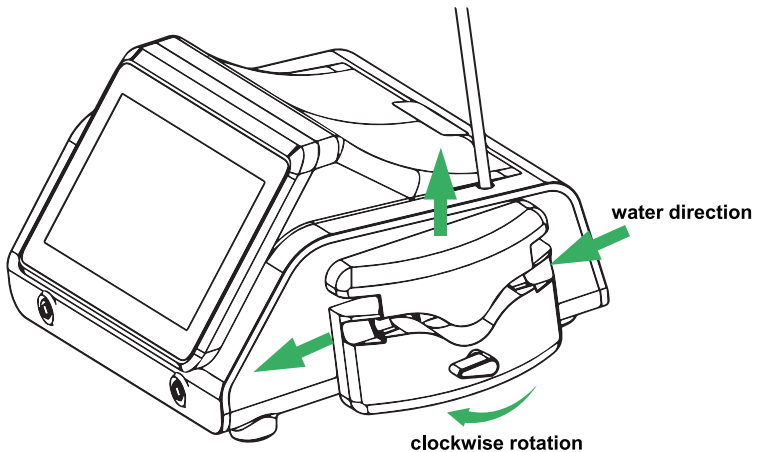

- ▶ Turn the pump knob clockwise to open the pump cover;
- ▶ Install the hose in the direction shown in the figure;
- ▶ Turn the pump knob counterclockwise to close the pump cover.

Tips !

Use the same procedure to remove the hose.



- ▶ Lay the cooling liquid hose of the device along the motor cable (clip) to the top of the motor and connect it;
- ▶ Fix the cooling liquid hose in the positioning ring of the handle front cover;
- ▶ Place the cooling liquid hose close to the motor cable, don't wrap it around or bend it, and fix it with the included clip.

5.7 Connect power

Attention !

The damaged power cord/no earth wire may cause electric shock.

- ▶ Please check the power cord before use. The socket must be equipped with protective contacts and accord with correlation regulations in each country.

Tips !

Tip: The ground wire will be used as functional ground (FE), not as protective ground (PE).

First, plug the power cord into the power socket of the device, and then plug the other end of the power cord into the socket of the power grid.

6. Use

6.1 The prepare of operation

6.1.1 Start the device

- ▶ Turn on the power switch and the device will perform a self-test.

Tips !

Tip: If you do not use the device for a long time, please turn it off.

6.1.2 The panel of dental implant machine

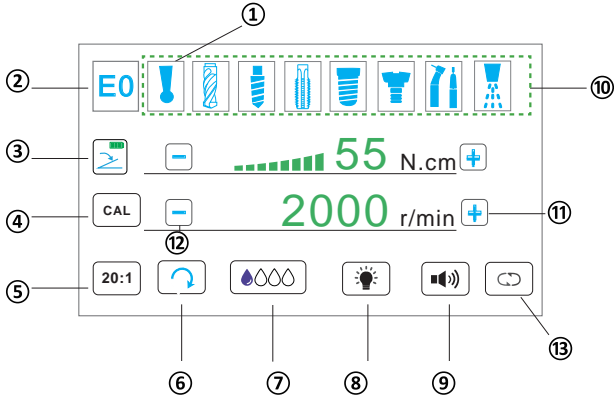

- ① the current program
- ② error code
- ③ pedal bluetooth connection
- ④ calibration
- ⑤ transmission ratio
- ⑥ motor rotation direction
- ⑦ cooling liquid flow rate
- ⑧ the brightness of light source
- ⑨ volume
- ⑩ program steps
- ⑪ plus key
- ⑫ minus key
- ⑬ switching mode

6.2 Programs





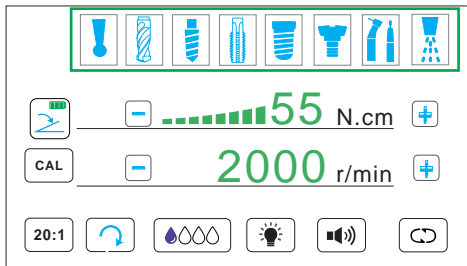



The device is based on frequently-used programs and guide user through graphics. The device has 8 programs. Through the visual guidance of the action, it is convenient to check whether the selected operation on the device is consistent with the current treatment step. This can largely eliminate wrong operations.

6.2.1 Choose program steps



- ▶ Select the corresponding program by touching;
- ▶ It's also select the program by pressing the P key on the wireless pedal, so that don't need to touch the device during the operation.

6.2.2 Program description



icon	option	description
	Round drill	Marking planting position
	Pilot screw	Fixed direction
	Twist drill	Expand to the required depth
	tapping	Thread preparation
	Implant placement	Screw in implant
	Cover screw	Screw in healing cap
	User's drill	Adding other programs, in addition to implant procedures, can also used to surgical operation or dental treatments such as polishing.
	Rinsing	Used to conveying cooling liquid.





6.2.3 Preset parameters of program

The speed, torque, transmission ratio and cooling liquid flow are preset for all operations at the factory.

All preset values can be changed, but for some programs, parameter changed can only be made within a specified range.

The following table lists the program's preset parameters and the adjustable value range.

icon	option	speed [rpm]	torque	gear ratio	cooling liquid flow
	Round drill	200-2000 1000 (D)	5-80 35(D)	20:1	0-4 2 (D)
	Pilot screw	200-2000 1000(D)	5-80 35(D)	20:1	0-4 2 (D)
	Twist drill	200-2000 1000(D)	5-80 35(D)	20:1	0-4 2 (D)

	tapping	20-100 50 (D)	5-80 25 (D)	20:1	0-4 2 (D)
	Implant placement	20-100 50 (D)	5-80 25 (D)	20:1	0-4 0 (D)
	Cover screw	20-100 50 (D)	5-35 20(D)	20:1	0-4 0 (D)
	User's drill	15-40000	5-80	1:1 1:5 20:1	00-4
	Rinsing	--	--	--	1-4

(D) = Preset parameters (factory settings)

Tips !

The range of adjustable speed and torque depends on the handpiece's gear ratio.

► The preset parameters of the program only for examples only. To avoid risks, it is imperative to follow the operating instructions of the implant& the instruments & tools.

To avoid risks, it is imperative that you follow the operating instructions for the implant as well as the instruments and tools.

6.3 Setting

6.3.1 The device can be set as follows:

- Motor rotation direction.
- The brightness of light source.
- Volume.

6.3.2 Choose program steps

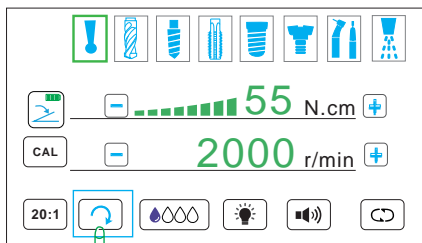

► The motor rotation direction icon at the pointed position in above indicates that it can be switched between motor forward and reverse rotation.

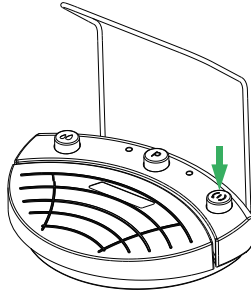

► The rotation direction of motor also can be changed through the rotation switch button of the wireless pedal. The after changed motor direction is displayed on the screen. To ensure safety, the motor reversal is not saved.

6.3.3 Setting the brightness of motor's source power

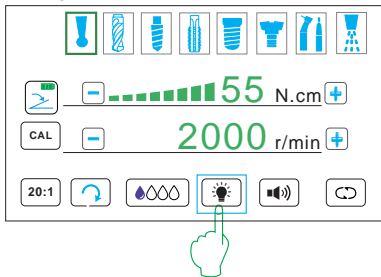

► The motor light icon at above picture is to turn on/off the LED of the motor.
► The after changed light will be saved automatically.

6.3.4 Setting volume

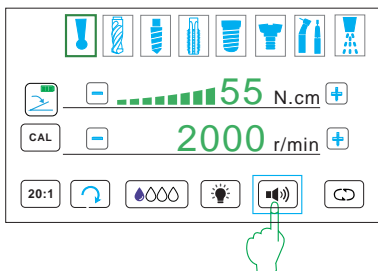

► The motor volume icon at above picture is to turn on/off the volume.
► The after changed volume will be saved automatically.

6.4 Change defaults

6.4.1 The following factory preset parameters can be changed within the specified range

- Maximum speed light source.
- Maximum torque.
- Cooling liquid flow.
- Transmission ratio

Tips !

Tip: If you do not use the device for a long time, please turn it off.

6.4.2 Adjust the maximum speed

Press and hold the position indicated by the arrow on the touch screen until the speed value flashes and the adjustment keys appears on the right side of the screen.

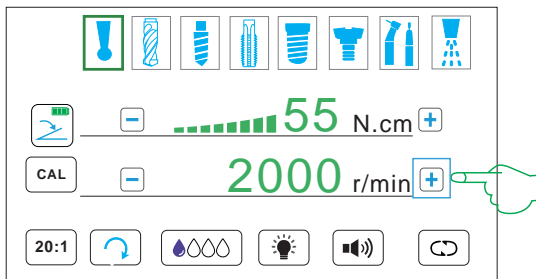

► Press "+" or "-" to adjust the highest speed within the specified range.

6.4.3 Adjust the maximum torque

Tips !

The device reduces power to prevent exceeding the set maximum torque. When the rotating device is blocked, the motor will stop rotating.

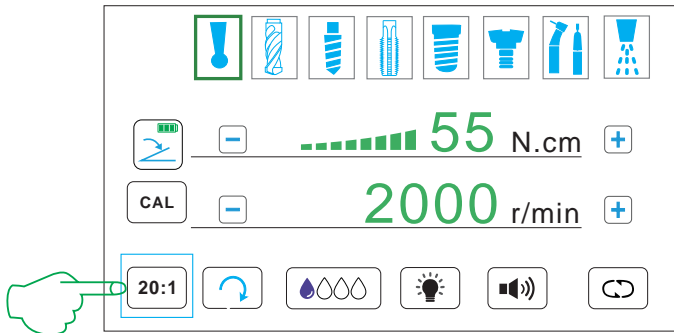

- ▶ Press the gear ratio icon at the position indicated by the arrow and select the gear ratio that matches the mobile phone you are using.
- ▶ The after changed gear ratio will be saved automatically.

6.4.4 Adjust the cooling liquid flow

Attention!

It may causes tissue damage if the cooling liquid flow insufficient.

- ▶ Please refer to the machine or tool instructions.
- ▶ Adjust the cooling liquid flow rate to a sufficiently high level.

There are 5 gears of cooling liquid flow from closed to maximum. There is an error between the actual flow and the nominal flow, generally within $\pm 50\%$.

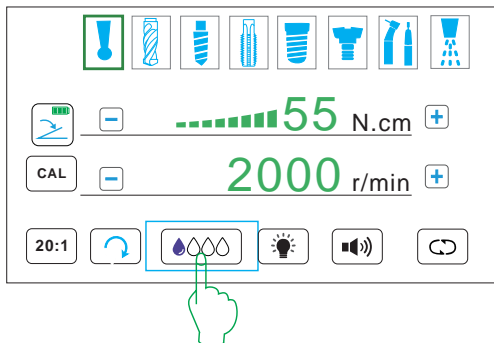
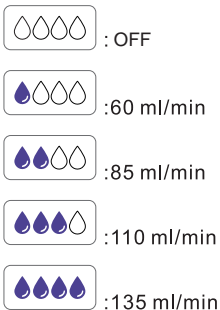

- ▶ Press the position indicated by touch arrow, can adjust the coolant delivery flow.

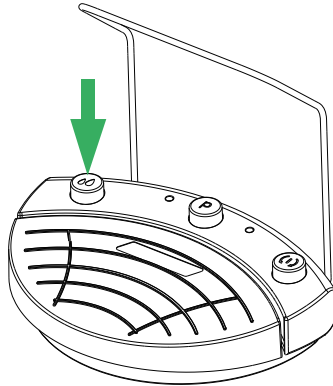

- ▶ The cooling liquid flow rate also can be adjusted through the control button of the foot controller, and the after changed value will be displayed on the display;
- ▶ The after changed flow rate will be automatically saved.

6.4.5 Adjust the transmission ratio

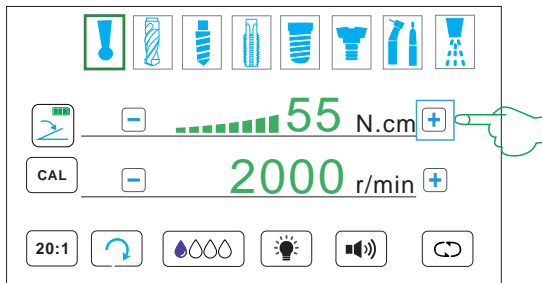

- ▶ Press the position indicated by the arrow on the screen, until the torque value flashes and the adjustment key appears on the right side of the screen.
- ▶ Press "+" or "-" to adjust the desired value within the specified range.

6.5 Function

6.5.1 Planting program

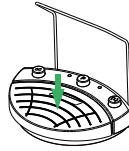
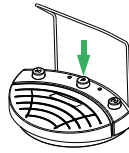
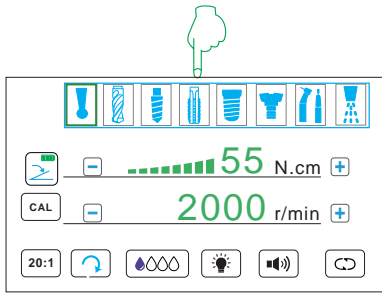

- ▶ Touch and select the required program, or select the program through the key on the wireless pedal;
- ▶ Select the motor's direction;
- ▶ Press black pedal of the wireless pedal to start the motor, and the motor rotates according to the set direction;
- ▶ The speed of the motor depends on the strength of black pedal. When the black pedal is pressed to the bottom, the motor rotates at the maximum speed set by the program;
- ▶ When the resistance encountered by the motor reaches the limit torque set by the program, the motor stops running;
- ▶ When the motor is running, the cooling liquid flow is supplied according to the set value;
- ▶ When the motor is running, the motor light according to the set brightness;
- ▶ Release black pedal of the wireless pedal to stop the motor, and the coolant supply stops and the lighting turns off.

Tips !

If you need to adjust or set the motor parameters, please refer to "6.3 Settings" and "6.4 Change defaults".

6.5.2 Free-to-use

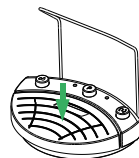
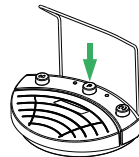
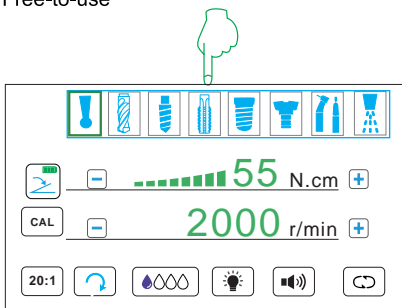

Tips !

Users can add other programs to the free-to-use program, which can be used as a surgical procedure or dental treatment such as polishing in addition to implant programs.

All parameters can be set in the free-to-use program.

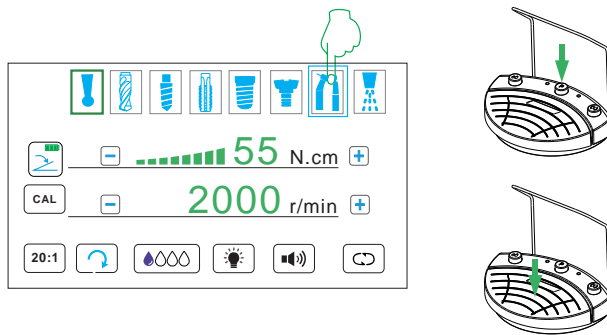

- ▶ Free-to-use programs can be selected by touch or by the button on the wireless pedal;
- ▶ Select the motor's direction;
- ▶ Press black pedal of the wireless pedal to start the motor, and the motor rotates according to the set direction;
- ▶ The speed of the motor depends on the strength of black pedal. When the black pedal is pressed to the bottom, the motor rotates at the maximum speed set by the program;
- ▶ When the resistance encountered by the motor reaches the limit torque set by the program, the motor stops running;
- ▶ When the motor is running, the cooling liquid flow is supplied according to the set value; When the motor is running, the motor light according to the set brightness;
- ▶ Release the pedal of the foot controller to stop the motor, and the coolant supply stops and the lighting will turn off after 10 seconds.

Tips !

If you need to adjust or set the motor parameters, please refer to "6.3 Settings" and "6.4 Change defaults "

6.5.3 Washing function

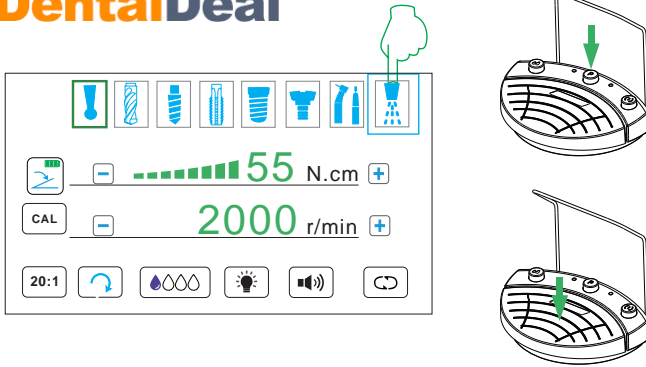

- ▶ The rinsing function can be used to deliver cooling liquid and instrument lighting;
- ▶ The motor does not rotate when the rinsing function is used;
- ▶ Select the rinsing program by touch, or select this program through the key on the pedal;
- ▶ Press black pedal on the wireless pedal to start the rinsing function, and the cooling liquid flow is supplied according to the set value;
- ▶ Release black pedal of the wireless pedal to turn off the rinsing function.

6.6 Restore the factory settings

The "Restore the factory settings" function can reset the program parameters to the factory default values.

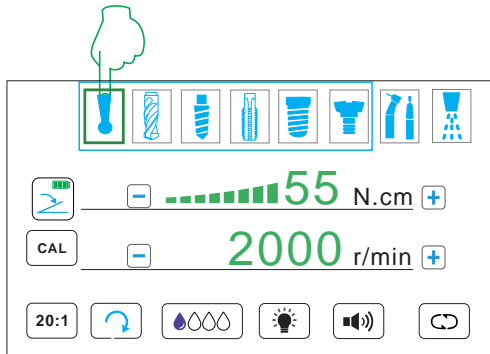

- ▶ Long press the icon of the program to be restored, the corresponding icon flashes, and the buzzer beeps twice to indicate completion.

6.7 Calibration motor

The motor calibration function compensates for torque deviations in the motor due to aging, etc. This function identifies machines that are not functioning properly and ensures more precise torque for the contra-angle machine.

Tips !

The motor plug must be inserted into the motor seat When using this function.

- ▶ The calibration function must use a contra-angle machine with a transmission ratio of 20:1, otherwise the calibration may be inaccurate;
- ▶ The calibration process must be repeated after changing the machine.

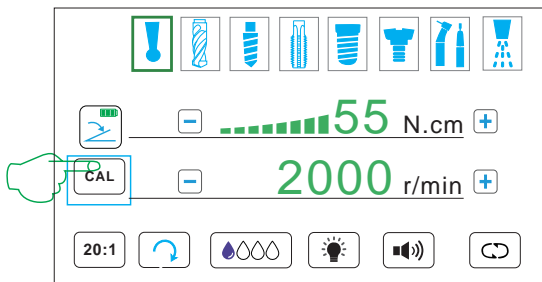

- ▶ Long press the "CAL" icon on the screen until it flashes;
- ▶ The motor starts and the calibration procedure is automatically executed;
- ▶ After the calibration is completed, the standby state is restored. If the calibration fails, an error code is displayed. For the corresponding error code and solution, see "8. Troubleshooting".

Attention !

There is no need to press the pedal during calibration, the motor will run automatically

- ▶ Don't touch the rotating equipment with your hands, otherwise there is a risk of injury..

7. Maintenance

7.1 Replace fuse

Tips !

If the host does not work, please check whether the fuse is blown (the fuse is located behind the host).

- ▶ Use a pointed tool to push open the buckle of the fuse holder and replace the fuse.

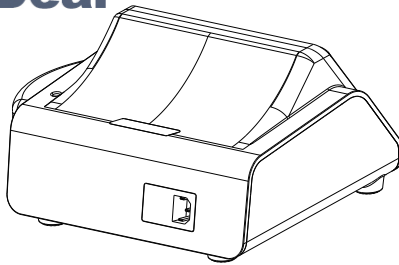

The specifications of fuse

220v

2A

7.2 Replace LED

Attention !

A hot bulb may cause a burn hazard.

► Don't touch the bulb after operation and wait for it to cool down.

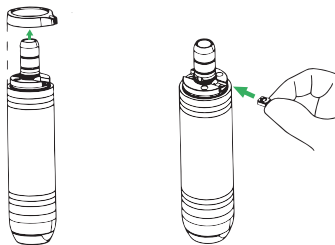

- Rotate and remove the fixing ring;
- If 1: The LED light is weak;
- Insert the new LED into the groove, align it and push it into the base, then install the fixing ring on the motor;
- Rotate and install the fixing ring.

Tips !

LED are only allowed to use DC voltage. To ensure proper function, the polarity must be connected correctly.

- ▶ Increase the voltage of the treatment machine until the light reaches the required lighting intensity. If 2: The LED lights up red or does not light up.
- ▶ Turn the LED 180° and reinstall it.

7.3 Replace o- ring

7.3.1 Replace fuse

Tips !

If the host does not work, please check whether the fuse is blown (the fuse is located behind the host).

- ▶ Use a pointed tool to push open the buckle of the fuse holder and replace the fuse.

- ▶ Rotate and remove the fixing ring;
- ▶ If 1: The LED light is weak;
- ▶ Insert the new LED into the groove, align it and push it into the base, then install the fixing ring on the motor;
- ▶ Rotate and install the fixing ring.

The specifications of fuse	
220v	2A

7.3.2 Replace LED

Tips !

If the host does not work, please check whether the fuse is blown (the fuse is located behind the host).

fault	reason	exclude
The device no reaction	The power is not turned on	Turn on the power switch on the back of the device
	The power cord is not plugged in properly	Plug in the power cord
	The fuse is blown	Replace the fuse
The motor does not rotate when press the black petal.	Foot switch poor connection	Check whether the wireless pedal cable is securely connected
	Motor poor connection	Check if the motor cable is securely connected
	Overloading	Check if the straight or contra-angle machine is stuck

	Select the washing program.	Select the program for the remaining motors to rotaterotation program.
No cooling liquid delivery	The cooling liquid flow is selected as off.	Please select the appropriate coolant flow rate.
	Hose clamp closed.	Open the hose clamp.
	Pump cover is not closed properly.	Check pump cover.
	Hose is bent	Check hose and straighten out bends.
Insufficient cooling liquid	Nozzle clogged	Clean or treat the nozzle and nozzle needle.
The motor is loud noisy or does not turn smoothly	The motor is not inserted or tightened properly.	Check that all connections / fittings are secure.
The straight or contra-angle machine does not light up	The lighting function is not turned on.	Turn on the lighting function.
	The straight or contra-angle machine is not properly plugged in.	Plug in the straight or contra-angle until it is locked in position.
	The LED is damaged.	Replace the LED.
	The polarity of the LED is reversed.	Turn the LED 180° and reinstall.
	The straight or contra-angle machine has no lighting function.	Need to use a straight or contra-angle machine with lighting function.
Insufficient torque	The transmission ratio is set incorrectly.	Set and use the transmission ratio to match the straight or contra-angle machine.
	The resistance of the straight or contra-angle machine is too high.	Recalibrate by the calibration function. Replace the straight or contra-angle machine.
Overheating	The motor is overloaded.	Wait for it to cool down before using.
Speed is too fast or too slow	The transmission ratio is set incorrectly.	Set and use the transmission ratio to match the straight or curved machine.
	The motor does not match the straight or contra-angle machine.	Recalibrate by the calibration function.

E0	Motor not inserted.	Insert motor.
E1	Reach the maximum torque of setting.	Release the pedal, release the torque or increase the torque value.
E2	Calibration failed	Check whether the contra-angle machine is unloaded during the calibration process. If not, release the load and recalibrate. If yes, replace the contra-angle machine, or oil or repair it.

8. Recycling and disposal of waste

Dispose of waste equipment in accordance with national regulations and standards.
Ensure that all parts do not cause pollution during the disposal process.

9. Cleaning, disinfection, and sterilization

Tips !

If the host does not work, please check whether the fuse is blown (the fuse is located behind the host).

9.1 Cleaning

Use a damp cloth to wipe all visible surfaces of the unit, the bottle holder, the surface of the foot control, and the cables.

9.2 Disinfection

Tips !

After treating each patient, surfaces of device that contacted with the patient or become contaminated must be disinfected.

► Using the soft and disposable cloth and a designated disinfectant, wipe all visible surfaces of the device, the pole, the foot control surface, and the cables.

9.3 Automatic hot cleaning and disinfection

► The motor handle can be automatically thermally cleaned and sterilized.

► Please use the automatic washer-disinfector that complies with ISO 15883.



Tips !

Automatic thermal cleaning and disinfection may damage and corrode the motor, such as the bearings.

- When performing automatic thermal cleaning and disinfection in an automatic washer-disinfector, prevent the detergent from entering the motor through the connecting shaft.
- When using an automatic washer-disinfector, the motor handle must be protected with a protective plug.

Attention !

Motor cables must be thermally cleaned at the same time

Attention !

Screw the protective plug into the motor.

Tips !

For details on thermal cleaning, please refer to the thermal cleaning machine operating instructions.

- To prevent product damage, ensure that the inside and outside of medical product is dry after the cycle.

9.4 Drying

Tips !

The coolant hose and its accessories are disposable items and don't require disinfection, sterilization, or drying.

- All disinfected and sterilized parts must be thoroughly dried before reuse.

9.5 Package

Tips !

The quality of the sterilization packaging bag must be reliable, and the use should comply with the corresponding specifications, and the sterilization process must meet the requirements!

- ▶ Seal the support rod and motor cable in the sterilization bag.

9.6 Sterilization

According to ISO 17665-1, the parts of the equipment that need to be sterilized are sterilized by steam sterilizer (high temperature and high pressure sterilizer).



Attention !

Incorrect sterilization methods can damage the product.

- ▶ Never use ethylene oxide for sterilization !



Attention !

Prevent corrosion to the product after sterilization.

- ▶ After the sterilization and drying process, the sterilized product must be removed from the high temperature and high pressure sterilizer immediately.



Tips !

Please observe the sterilization regulations.

- ▶ The coolant container must be disposed and the replaced hose after each patient treatment.
- ▶ Products approved for sterilization have a temperature resistance of up to 136°C.

The following equipment parts are allowed to be sterilized at 134°C:

- The coolant container must be discarded and the replaced hose after each patient treatment.

Sterilization requirements:

- 134°C for not less than 5 minutes.



Tips !

The sterilized parts is allowed to cool to ambient temperature and dry before reuse.

9.7 Storage

Storing sterilized product must be observed All hygiene requirements. Protect from dust and store dry.

10. After-sale service

10.1 Quality assurance

The manufacturer provides a warranty to the end customer for the product functions, materials and processing for the products described in the delivery order. The warranty for the device host, pedal, motor handle and cable is 24 months from the date of purchase of the product. The manufacturer provides free replacement or repair service for reasonable product defect complaints within the period listed below.

But should meet the following conditions:

- ▶ Other requirements, in particular, damages remedy claim, the manufacturer is not liable in the

event of a violation of mandatory legal provisions;

- ▶ The warranty does not cover lamps, glass products, rubber parts or the color stability of plastic parts;
- ▶ Presenting the original delivery receipt to the manufacturer is an essential prerequisite for the warranty to take effect.

10.2 Disclaimer

The manufacturer will not be held responsible for accidents, equipment damage or personal injury caused by:

- ▶ Repairs by personnel not authorized by the manufacturer.
- ▶ Changes or modifications to the product by the customer or a third party;
- ▶ Maintenance or repairs using parts not specified by the manufacturer;
- ▶ Operations not in accordance with the operating procedures described in this manual, or failure to comply with the safety precautions and tips in this manual;
- ▶ Workplace conditions and environmental conditions or installation conditions that do not meet the conditions specified in this manual, such as incorrect power supply;
- ▶ Force majeure such as fire, earthquake, flood, lightning, natural disasters, etc.

11. Running Environment, transport and storage conditions

11.1 Running Environment

Warning !
Improper working conditions can damage the electrical safety of the equipment.

Environment Temperature	+5 °C --+40 °C
Relative humidity	20%-80%RH
Atmospheric pressure	860hPa-1060 hPa

11.2 Transport and storage conditions

Environment Temperature	-10 °C --+55 °C
Relative humidity	93%RH
Atmospheric pressure	500hPa-1060hPa

12. The content of standard packing

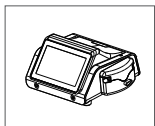

host



Wireless pedal



AC power cord



motor
(with motor line)



support rod

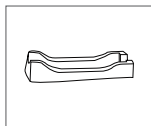

motor silicone seat



line clip



fuse pipe

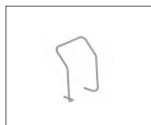

handle of foot
control



infusion tube

Contents II for Ultrasonic Bone Surgery Machine

1. Product Introduction

1.1 Foreword

Please read this manual carefully before installing, using, maintaining or performing any other activities on this equipment.

Key Points: To avoid personal injury or property loss, please carefully read the points marked with "Safety Requirements" in this manual that require special attention.

Safety requirements based on risk level are listed in the following instructions:

 Danger (Most of the time it will cause personal injury)

 Warning (It may cause property damage)

The purpose of this manual is to make the operator understand the safety requirements, installation process, instructions for correct use and equipment maintenance. If you encounter any unexpected problems, please contact the after-sales service center of Guilin Woodpecker Medical Equipment Co., Ltd.

The manufacturer will not be responsible for any personal injury or property loss caused by any user's artificial or unauthorized tampering or modification of the equipment.

This manual is strictly prohibited from being used for purposes other than equipment installation, use and maintenance.











1.2 Product contraindications and precautions

- (1) It is forbidden for patients with hemophilia;
- (2) It is forbidden for patients or doctors with pacemakers;
- (3) It should be used with caution in patients with heart disease and young children;
- (4) Patients with oral and maxillofacial infections, uncured oral mucosal diseases, periapical diseases, gum diseases, periodontal diseases, oral tumors, etc. are prohibited from using this product;
- (5) Patients with allergic constitutions and a history of drug allergies are prohibited from using this product;
- (6) Patients with mental disorders should use this product with caution;
- (7) Patients with severe systemic infectious or systemic diseases, such as those with heart, liver, kidney, hematopoietic system, digestive system and endocrine system diseases, should use this product with caution;
- (8) Pregnant or lactating women, and women of childbearing age who are planning to have children in the near future should use this product with caution.

1.3 Scope of Application

This product is suitable for osteotomy and bone plastic surgery in dentistry.

1.5 safety requirements

-  **Danger:** only qualified professionals can operate this device.
- This device is only allowed to be used by professional, trained personnel (such as surgeons). Correct use of this device will not cause side effects; improper use of this device will cause heat to be transferred to the tissue, which may cause tissue damage.
-  **Danger:** scope of application
- The device may only be used for the intended use as described in this manual (see 1.3). Failure to follow the instructions for use of this device may result in damage to the patient, operator, device or operational failure.
-  **Danger:** contraindication.
- Electrosurgical blades may interfere with the proper functioning of this device.
-  **Danger:** Cleaning, disinfection and sterilization of new or repaired products.
- All new or repaired products are transported in a non-sterile environment. Before being used for therapeutic purposes, all new or repaired products must be cleaned, disinfected and sterilized in strict accordance with the requirements of Chapter 8.
-  **Danger:** check the condition of the equipment before treatment.
- Always ensure that there is no water under the device; before each treatment, check that the device is in normal operation and its components are effective; if any problems occur when operating the device, please do not perform any operations; if there is any problem with the device, please contact the authorized technical service center in time.
-  **Danger:** damage and wear of inlays.
- High frequency vibration and wear may occasionally cause the inlay to break. Inlays that have changed shape are very easy to break during use. Any such inlays should never be used. Patients should be instructed to breathe through their nose during treatment to avoid inhaling fragments of the dislodged inlay.
-  **Danger:** the device must never be installed in areas where there is a risk of explosion.
- This device cannot be operated in areas where flammable gases (anesthetic mixture, oxygen, etc.).
-  **Danger:** make sure the pump cover of the peristaltic pump is closed.
- The foot switch of the ultrasonic bone scalpel machine must never be activated when the pump cover of the peristaltic pump is open. (See Figure 5-Reference B) Moving parts may injure the operator.
-  **Warning:** contraindication.
- Don't perform this treatment on metal or ceramic prostheses. The vibrations from the ultrasound can cause these prostheses to disintegrate.
-  **Attention Points.**
- After autoclaving the handle, wait until it cools completely before use.

1.6 The basic principles of product

1.6.1 Working principle

The electrical energy is converted into mechanical energy through the piezoelectric ceramic transducer, and the bone tissue at the location where cutting is required is completely destroyed

through high-frequency oscillation, thereby achieving the purpose of cutting the bone tissue.

1.6.2 Action Principle

The ultrasonic bone knife uses high-intensity energy-focusing ultrasonic technology to convert electrical energy into mechanical energy through a piezoelectric ceramic transducer. The ultrasonic frequency micro-oscillation working tip is used for bone cutting. The high-frequency ultrasonic oscillation vaporizes the water in the contacted tissue cells and breaks the protein hydrogen bonds, thereby completely destroying the bone tissue to be cut.

2. Product Nameplate

2.1 The description of Nameplate

An accurate description of this nameplate and the serial number of the device will enable our after-sales service center to respond to your inquiry more quickly and efficiently. The device's nameplate is displayed on the back of the device.

2.2 Equipment parameter nameplate

Each device has its own nameplate on the back with its technical parameters and serial number (see Figure 1). For other data, please refer to this manual (see point 15).

2.3 Handle parameter nameplate

The ultrasonic bone knife handle's plastic sleeve is engraved with its trademark and serial number (see Figure 2).



Figure 2

2.4 Foot pedals parameter nameplate

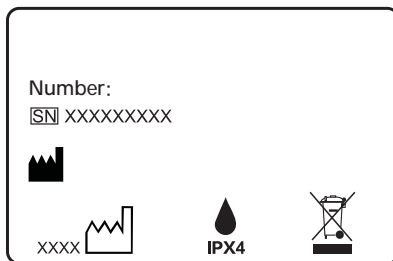

Figure 3

3. Testing of equipment

3.1 During the test, all components are subjected to a certain working cycle for a certain period of time.

3.2 The test emphasizes that any failure is caused by the faulty component.

3.3 This step ensures the function and reliability of all components.

4. Transport

4.1 Avoid excessive impact and vibration during transportation, place with care and avoid inversion.

4.2 Do not mix with dangerous goods during transportation.

4.3 Avoid exposure to sunlight or rain or snow during transportation.

5. Accessories description

Please refer to the packing list for the machine configuration.

 Warning: The handle and the wire cannot be separated.

Name	Quantity
Device	1
Limiting wrench	1
Bone knife with threaded handle	1
Peristaltic pump tube connector	Mark in the packing list
Handle connector	1
Multi functional foot pedal	1
Work tip bracket	Mark in the packing list
Work tip	Mark in the packing list
Power cord input	1
Infusion bottle support rod	1
Silicone handle bracket	Mark in the packing list
Pump pipe	Mark in the packing list

6. Installation

6.1 Safety requirements during installation

 Danger: The premise of equipment installation and wiring is that the installation must comply with appropriate standards and relevant electrical safety requirements.

 Danger: Never install the equipment in places where there is a risk of explosion. The equipment cannot be operated in areas with flammable gases (anesthetic mixtures, oxygen, etc.).

 Danger: Install the equipment in a place where it can be protected from impact and splashing of water or other liquids.

 Danger: Don't install the equipment near or on a heat source. It must be installed in a place where the surrounding air is adequately circulated. Leave enough space around, especially for exhaust fans and back positions.

- ⚠ Warning: Don't place the unit in direct sunlight or UV light.
- ⚠ Warning: The device can be transported, but it must be handled with extreme caution.
- ⚠ Warning: Before connecting the wires to the device, make sure the connections are dry. If necessary, blow dry with an air gun.

6.2 Initial installation

In order to ensure the normal operation process, the installation of the equipment must be strictly operated according to the requirements of the manual.

6.3 Connect attachments

⚠ Warning: The accessories listed in each step below must be properly connected to the ultrasonic bone surgical machine.

6.3.1 Foot pedal installation:

Connect the foot control handle of the foot switch to the foot pedal socket and tighten the two fastening screws; (Figure 5-refer to E)

6.3.2 Power cord installation:

Insert the output end of the power cord into the power socket of the device; (Figure 5-refer to D)

6.3.3 Infusion bottle support rod installation

Insert the infusion bottle support rod into the hole on the right rear of the housing; (Figure 5-refer to A)

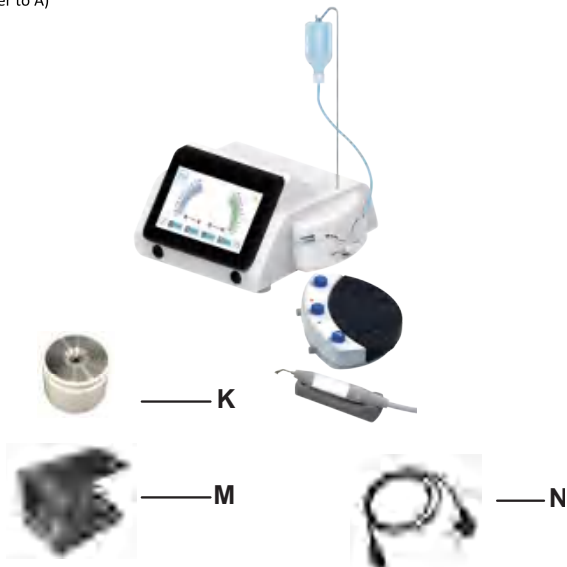

Figure 4



Figure 5

6.3.4 Installation of infusion bottle:

Hang the infusion bottle (the infusion bottle is purchased saline injection) on the infusion bottle support rod k.

6.3.5 Connection between pump tube and handle:

A. In the disinfection box (see Figure 4-reference L), insert the pump tube connector (smaller end) into the handle water supply pipe, and insert the larger end of the pump tube connector into the pump tube.

B. Connect the saline bottle plug to the other end of the pump tube and insert it into the saline bottle.

6.3.6 Installation of handle:

A. Place the handle on the silicone handle bracket (Figure 4-reference H), and insert one end of the handle tail wire into the small groove of the bracket to prevent it from falling off.

B. Insert the handle plug into the handle socket of the device. (Figure 5 reference B)

6.3.7 Installation of pump tube on peristaltic pump:

A. Open the pump door (Figure 6-reference A) to the OPEN position.

B. Place the pump tube in the impeller (Figure 6-reference B and C).

C. Close the pump door completely to the CLOSE position (Figure 6-reference D).

 **Danger:** Make sure the pump door is completely closed

The multifunctional foot pedal of the ultrasonic bone scalpel must never be activated with the peristaltic pump door open. Moving parts can injure the operator.



Figure 6

6.3.8 Installation of bone knife working tip

A. Select the working tip to be used from the bone knife working tip holder in the sterilization box (see a holder full of bone knife working tips).

B. Screw the bone knife working tip onto the bone knife handle (see Figure 7)

C. Tighten the bone knife working tip with a torque limiter wrench until you hear a "click" sound from the torque limiter wrench.



Figure 7

6.3.9 The whole machine after all accessories are installed (Figure 8)



Figure 8

6.3.10 Turn on the power switch (Figure 5-reference C) and start using the machine after the display is normal:

Press the pedal, the machine starts working, and the LED light on the handle lights up; release the pedal, the machine stops working, and the handle LED light goes out after a delay of 10 seconds.

7.Use

7.1 Panel control

This chapter introduces the front panel of the ultrasonic bone cutting machine, which displays

the operation interface intuitively, enabling the operator to better use the machine.

(1) Schematic diagram of bone cutting function panel control:

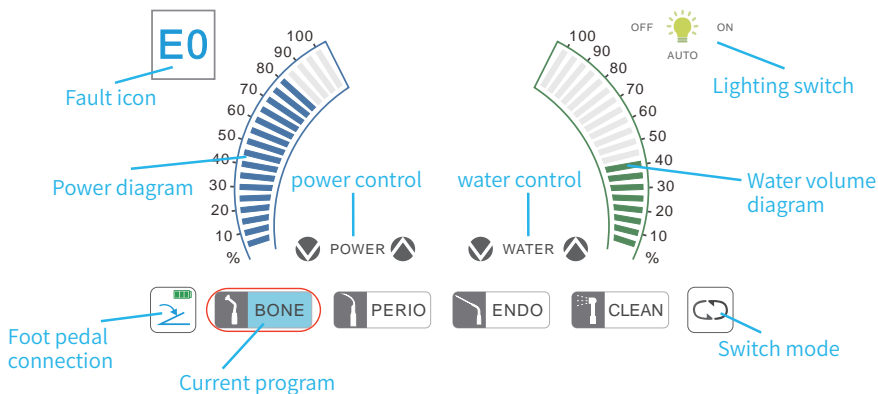

Figure 9

(2) Schematic diagram of periodontal mode function panel control:

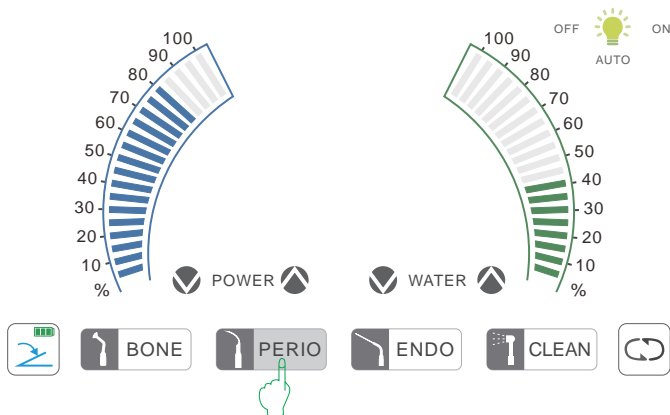

Figure 10

(3) The panel control diagram of root canal mode function:

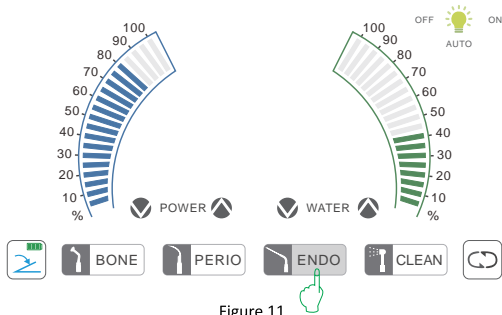

Figure 11

(4) The panel control diagram of cleaning function:

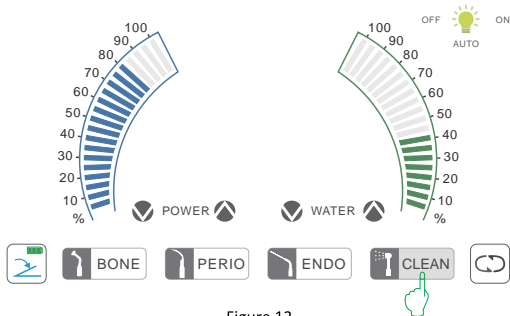

Figure 12

(5) Alarm interface diagram:

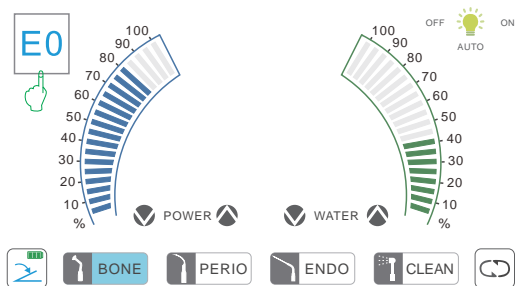

Figure 13

To ensure the maximum safety of patients and doctors, please clean, sterilize and disinfect the ultrasonic bone knife handle, working tip, pump tube, pump tube connector, force limiter and handle bracket in time after each treatment. ! Warning: Contraindications.

Ultrasonic vibrations can cause the disintegration of metal or ceramic prosthesis prostheses.

Do not treat on such prostheses.

 Warning: Contraindications.

Ultrasonic vibrations can cause the disintegration of metal or ceramic prosthetics. Treatment should not be performed on such prosthetics.

 Warning: Contraindications.

After autoclaving the handle, wait until it cools completely before use.

 Danger: The electronic circuits in the connector must be kept dry.

Before connecting the wire to the device, especially after autoclaving, make sure that the connection is dry, if necessary, use an air gun to blow it dry.

 Warning: For correct operation, the foot pedal must be depressed and activated before the tip is used for treatment. This allows the electronic circuit to find the optimal oscillation point without any hindrance, thus obtaining the best performance.

 Warning: For spray treatment, only use tips that can pass liquids.

7.4 System protection and warnings

In order to ensure the normal use of this device and avoid harm to patients caused by misoperation or negligent operation, this device is equipped with a system protection function to remind users to use this device safely. The specific warning information on the display screen is as follows: (See Figure 13 in Chapter 7.1 for a schematic diagram)

a) Alarm 01:

① The internal resistance of the handle is abnormal.

b) Alarm 02:

① The ultrasonic module is damaged;

② The handle is not connected properly or fails.

c) Alarm 03: The cooling fan fails.

d) Alarm 04: The peristaltic pump is blocked or fails.

e) Alarm 05: The power supply is out of range

f) Alarm 06:

① The working tip is not tightened or worn or damaged; ② The handle fails.

g) Alarm 07:

① The power supply of the ultrasonic generator module may be damaged;

② Please restart the device. If the problem occurs again, please contact our company.

7.5 Instructions for use

a) Open the air inlet on the disposable infusion tube.

b) Use a torque wrench to tighten the tip.

c) The correct steps for using a torque wrench (Figure 4 - Reference K) are as follows:

① Hold the handle tightly;

 Warning: Don't hold the end of the handle or the connection, hold the plastic shell and do not turn it when tightening.

- ② Turn the wrench clockwise until the bayonet is locked (makes a "click" sound);
- ③ The tip is now correctly installed in place.
 - d) Make sure the ultrasonic bone knife handle is correctly connected to the handle socket.
 - e) Check the function selected on the display screen. If the required function is different from the selected one, adjust the corresponding mode touch key selection (see Section 7.1 Panel Control) to switch.
 - f) Check the power selected on the display screen. If the required power level is different from the selected one, use the "+" or "-" key of the power to reset it.
 - g) Check the water volume selected on the display screen. If the required water volume is different from the selected one, use the "+" or "-" key of the water volume to reset it.

7.6 Requirements for keeping the equipment in normal operation

1. Check the wear of the working tip regularly and replace it in time if there is a problem;
2. Do not change the shape of the working tip by bending or filing;
3. Replace the deformed or damaged working tip in time
4. Ensure that the working tip thread and surface are clean;
5. If the working tip is seriously aged, the equipment will stop working.

8. Cleaning, disinfection and sterilization

8.1 Cleaning, disinfection and sterilization

 Warning: Failure to clean the water system will result in salt crystals that will seriously damage the equipment.

 Warning: The handle and tail line cannot be separated.

1. Replace the infusion bottle or infusion bag. It is recommended that the liquid in the infusion bottle or infusion bag is desalted water;
2. Check whether the water system is installed correctly;
3. Adjust the mode to the cleaning function (see Figure 12);
4. Press the foot switch to start the cleaning cycle, ensure that the cleaning lasts for more than 20 seconds, then take the pump tube out of the water, and continue to press the foot pedal to drain the clean water in the pipeline;
5. After the cleaning operation is completed, dry the parts that have undergone the cleaning cycle.

8.2 Cleaning and disinfection equipment surface

 Danger: The exterior of the device cannot prevent liquid penetration. Don't spray liquid directly onto the surface of the component housing.

 Danger: The housing cannot be sterilized by high temperature. Perform the following steps after each treatment:

- 1 Remove the working tip from the handle;
2. Use a damp cloth with mild detergent or a disinfectant with a pH of 7 to clean and disinfect the housing surface, wiring, and connectors. Follow the manufacturer's instructions for disinfection

and allow to air dry after disinfection.

⚠️ Note: It is recommended to use only a disinfectant with a pH of 7 for disinfection. Some disinfection methods using alcohol may discolor or damage plastic materials.

8.3 Sterilization process

⚠️ Warning: Only high temperature and high pressure steam sterilization can be used.

To avoid bacterial or viral infection, any other sterilization techniques (such as dry heat, radiation, gas, low temperature plasma, etc.) cannot be used. After each treatment, the following parts should be cleaned, disinfected and sterilized:

- 1 Handle (see Figure 4 - reference G)
- 2 Working tip (see Figure 4 - reference M)
- 3 Working tip bracket (see Figure 4 - reference M)
- 4 Limiting wrench (see Figure 4 - reference K)
- 5 Pump tube (see Figure 4 - reference E)
- 6 Pump tube connector (see Figure 4 - reference J)
- 7 Saline bottle plug (see Figure 4 - reference C)
- 8 Silicone handle bracket (see Figure 4 - reference H)
- 9 Sterilization box (see Figure 4 - reference L)

All the above parts can withstand 20 minutes of 134°C, 0.22MPa high temperature steam sterilization.

8.4 High temperature and high pressure steam sterilization of the handle

⚠️ Warning: The handle and the handle wire cannot be separated.

⚠️ Warning: Don't immerse the handle in any disinfecting liquid to cause possible damage.

⚠️ Warning: Don't sterilize the handle and the working tip together.

⚠️ Warning: The connection between the handle plug and the handle socket must be kept dry. After sterilization, before connecting the handle to the device, ensure that the electrical connections of all connectors are completely dry. If necessary, you can dry them by blowing the connections with a hot hair dryer.

⚠️ Warning: After the sterilization process, ensure that the handles are completely dry before use.

⚠️ Note: It is recommended to use a disinfectant diluted with water with a pH value of 7 to disinfect the handle. Using alcohol disinfection may cause the plastic material to fade or damage.

1. Wash the handle carefully and pay special attention to whether the threads of the working tip are damaged;
2. Disinfect the handle with a damp cloth containing mild detergent or a disinfectant with a pH value of 7;
3. Dry the connection by blowing it with a hot hair dryer;
4. Seal the handle separately in a disposable package (without any working tip);
5. Sterilize the handle with high temperature and high pressure steam.

After sterilization, before connecting the handle to the host, ensure that the electrical connections of all connectors are completely dry. If necessary, dry them by blowing the connections with a hot hair dryer.

8.5 High temperature and high pressure steam sterilization of working tips

1. Clean the tip in distilled water (preferably in an ultrasonic bath).
2. Drying tips.
3. Disinfect the tip with a disinfectant diluted in water with a pH of 7 and be careful to dry it completely.

 **Warning:** After the sterilization process, ensure that the handles are completely dry before use.

4. Sterilize the working tip with high temperature and high pressure steam;
5. Seal the working tip independently into a disposable package.

8.6 High-temperature and high-pressure steam sterilization of force-limiting wrenches

1. Clean the wrench;
2. Disinfect the force-limiting wrench with a disinfectant diluted with water and pH 7 and carefully dry it completely;
3. Sterilize the wrench with high-temperature and high-pressure steam;
4. Seal the wrench separately in a disposable package.

8.7 High-temperature and high-pressure steam sterilization of pump tubes

1. Clean the pump tubes;
2. Disinfect the pump tubes with a disinfectant diluted with water with a pH value of 7 and carefully dry them completely;
3. Sterilize the pump tubes with high-temperature and high-pressure steam;
4. Seal the pump tubes independently in disposable packaging.

8.8 High-temperature and high-pressure steam sterilization of pump tube connectors

1. Clean the pump tube connectors;
2. Disinfect the pump tube connectors with a disinfectant diluted with water with a pH value of 7 and carefully dry them completely;
3. Sterilize the pump tube connectors with high-temperature and high-pressure steam;
4. Seal the pump tube connectors independently in disposable packaging.

8.9 High-temperature and high-pressure sterilization of the handle bracket

1. Clean the handle bracket;
2. Disinfect the handle bracket with a disinfectant with a pH value of 7 diluted with water and carefully dry it completely;
3. Sterilize the handle bracket with high-temperature and high-pressure steam;

4. Seal the handle bracket independently in a disposable package.

9.Storage and maintenance

1.2 The device should be placed with care, away from the source of vibration, and installed or stored in a cool, dry and ventilated place.

1.3 Don't mix with toxic, corrosive, flammable and explosive items during storage.

9.3 The product should be stored in an environment with a relative concentration of 10%~93%, an atmospheric pressure of 70kPa~106kPa, and a temperature of -20℃~+50℃.

9.4 When the device is not in use, turn off the power switch and unplug the power plug; when not in use for a long time, it should be powered on and watered once a month for five minutes each time.

9.5 Power supply cable

Danger: Check the integrity of the cable frequently. If it is damaged, please replace it with Woodpecker accessories.

10.Fuse Replacement

 Danger: Shutdown components.

When performing the following maintenance activities, press the power switch (see Figure 5 - Reference C) to turn off the device and disconnect the power cord from the main power supply.

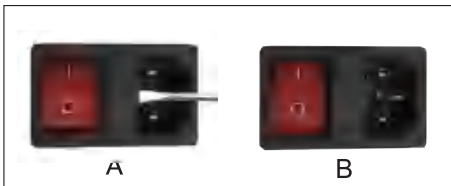



Figure 14

1. Insert a flat-blade screwdriver into the groove of the fuse compartment below the power port and move it (see Figure 14-reference A);

2. Pull out the fuse compartment (see Figure 14-reference B);

 Danger: Select and replace the fuse according to the label attached to the bottom of the component; 3. Put the fuse compartment back to its original position (see Figure 14-reference B).

11.Disposal procedures and precautions

 Danger: Medical waste.

Medical waste is defined as follows and should be replaced in a timely manner:

- Working tips, when aged or damaged.
- Infusion tubing, after each treatment.
- Pump tubing, after 8 sterilization cycles.
- Force-limiting wrench, when aged or damaged.

12. Working tip

12.1 Sharp working tips

The sharp edges of these working tips can be used more efficiently and effectively in bone structural surgery. When a fine, tiny incision is required, these working tips can be used for osteotomy and osteoplasty; similarly, some sharp working tips can be used for bone fragment removal-osteoplasty techniques.

12.2 Smooth working tip

Smooth working tip has a rounded shape and is used for bone structures with precisely controlled angles; smooth working tips are used for osteotomies and can be used for complex and delicate structures when necessary, such as maxillary augmentation or implant surgery.

12.3 Blunt working tips

Blunt working tips are used for soft tissue dissection, such as sinus lift surgery or lateral nerve surgery. In periodontology, such working tips can be used to smooth root surfaces.

13. Electromagnetic Compatibility description

13.1 Electromagnetic Compatibility



Attention !

This device complies with the relevant requirements of electromagnetic compatibility.

- ▶ Users should install and use the device according to the electromagnetic compatibility

information provided in the accompanying documents.

▶ Portable and mobile radio frequency communication equipment may affect the performance of this device. Avoid strong electromagnetic interference when using it,

▶ Such as near mobile phones, microwave ovens, etc.

▶ For detailed instructions and manufacturer's statements, please see the attachment.

Warning !

This device should not be used close to or stacked with other devices. If it must be used close to or stacked, it should be observed and verified to operate normally in the configuration in which it is used.

Except for cables sold by the manufacturer of this device as spare parts for internal components, the use of accessories and cables other than those specified may result in increased emissions or reduced immunity of this device.

number	name	cable length(m)	whether to block	notes
1	Motor line	2	no	
2	Bone knife line	2	no	

13.2 The statement of Guide and manufacturer-electromagnetic emission

This device is intended to be used in the electromagnetic environment specified below. The purchaser or user of the device should ensure that it is used in such an electromagnetic environment.

Emission experiment	Compliance	Electromagnetism environment
GB4824RF emission	1 group	This device uses RF energy only for its internal functions; therefore, its RF emissions are very low and are not likely to cause any interference in nearby electronic equipment.
GB4824 Rf emission	Class B	This equipment is suitable for use in all establishments directly connected to the public low-voltage power supply network that supplies buildings used for domestic purposes.
Gb17625.1 Harmonic Emission	Class A	
GB17625.1 voltage fluctuation / scintillation emission	Class A	

13.3 The statement of Guide and manufacturer-electromagnetic immunity

This device is intended to be used in the electromagnetic environment specified below. The purchaser or user of the device should ensure that it is used in such an electromagnetic environment.

Emission experiment	Gb9706 test level	Comply with level	Electromagnetism environment
electrostatic discharge (ESD) GB/T17626.2	± 6kV Discharge contacted ± 8kV air discharge	± 6kV Discharge contacted ± 8kV air discharge	Floors should be wood, concrete or tile; if floors are covered with synthetic material, the relative humidity should be at least 30%.
Electrical Fast Transient Burst GB/T17626.2	± 2kV For power lines ± 1kV For input/output lines	± 2kV For power lines	Mains power quality should be that of a typical commercial or hospital environment.

Surge GB/T17626.5	± 1kV differential-Mode Voltage ± 2kV common mode voltage	± 1kV differential-Mode Voltage ± 2kV common mode voltage	Mains power quality should be that of a typical commercial or hospital environment.
Voltage dips, short interruptions and voltage variations on the power input line GB/T17626.11	<5%UT, for 0.5 weeks (above UT, >95% Sag.) 40%UT, for 5 weeks (above UT, 60% Sag.) 70%UT, for 25 weeks (above UT, 30% Sag.) <5%UT, for 5s (above UT, >95% Sag.)	<5%UT, for 0.5 weeks (above UT, >95% Sag.) 40%UT, for 5 weeks (above UT, 60% Sag.) 70%UT, for 25 weeks (above UT, 30% Sag.) <5%UT, for 5s (above UT, >95% Sag.)	Mains power quality should be that of a typical commercial or hospital environment. If the user of the equipment requires continued operation during power mains interruptions, it is recommended that the equipment be powered from an uninterruptible power supply or a battery.
power frequency magnetic fields (50/60Hz) GB/T17626.8	3A/m	3A/m	The power frequency magnetic field should be characteristic of the power frequency magnetic field levels in a typical location in a hospital environment.

Note: UT refers to the AC network voltage before applying the test voltage.

13.4 The statement of Guide and manufacturer-electromagnetic immunity

This device is intended to be used in the following electromagnetic environment. The purchaser or user of the device should ensure that it is used in this electromagnetic environment:

Immunity test	Gb9706 test level	Comply with level	Electromagnetism environment
Rf conduction GB/T 17625.6	3Vrms 150kHz to 80MHz	3Vrms	Portable and mobile RF communications equipment should not be used closer to any part of the equipment, including cables, than the recommended separation distance. This distance should be calculated using the equation appropriate to the frequency of the transmitter. Recommended separation distance $d=1.2\sqrt{P}$ $d=1.2\sqrt{P}$ 80MHz to 800MHz $d=2.3\sqrt{P}$ 800MHz to 2.5GHz Where P is the maximum output power rating of the transmitter according to the transmitter manufacturer in watts (W), and d is the recommended isolation distance in meters (m). b Field strengths from fixed RF transmitters are determined by an electromagnetic site survey and should be less than the compliance level in each frequency range b. Interference may occur in the vicinity of equipment marked with the following symbol. 
Rf radiation GB/T 17626.3	3Vm 80MHz to 2.5GHz	3Vm	

Note 1: At 80MHz and 800MHz, the formula for the higher frequency band is used.

Note 2: These guidelines may not be appropriate in all situations, as electromagnetic propagation is affected by absorption and reflection from structures, objects and people.

a Field strengths from fixed transmitters, such as base stations for radio (cellular/cordless) telephones and land mobile radios, amateur radio, AM (amplitude modulation) and FM (frequency modulation) radio broadcast, and TV broadcast cannot be predicted theoretically with accuracy. To assess the electromagnetic environment due to fixed RF transmitters, an electromagnetic site survey should be considered. If the measured field strength in the location of the equipment exceeds the applicable RF compliance level above, the equipment should be

observed to verify normal operation. If abnormal performance is observed, additional measures may be necessary, such as reorienting or relocating the equipment.

b Over the entire frequency range of 150KHz to 80MHz, the field strength should be less than 3V/m.

13.5 Recommended separation distances between portable and mobile RF communications equipment and this equipment

This equipment is intended for use in an electromagnetic environment 7 in which radiated RF disturbances are controlled. The purchaser or user of the equipment can prevent electromagnetic interference by maintaining a minimum distance between portable and mobile RF communications equipment (transmitters) and the equipment as recommended below, according to the maximum output power of the communications equipment.

Rated maximum output power of the transmitter/W	Isolation distance corresponding to different transmitter frequencies/m		
	150kHz~80MHZ $d=1.2/P$	80MHz-800MHZ $d=1.2P$	800MHz-2.5GHz $d =23VP$
0.01	0.12	0.12	0.23
0.1	0.38	0.38	0.73
1	1.2	1.2	2.3
10	3.8	3.8	7.3
100	12	12	23

For transmitters rated at maximum output power not listed in the above table, the recommended isolation distance d , in meters (m), can be determined using the formula in the column corresponding to the frequency of the transmitter, where P is the maximum output power rating of the transmitter provided by the transmitter manufacturer, in watts (W).

Note 1: At 80MHz and 800MHz, the formula for the higher frequency band is used.

Note 2: These guidelines may not be appropriate in all situations, as electromagnetic propagation is affected by absorption and reflection from structures, objects and people.