

DentalDeal

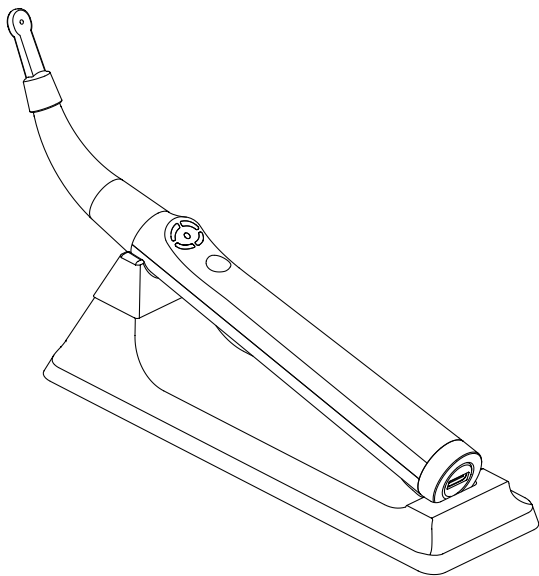

IMPLANT LOCATOR

Instruction Manual
Please read this manual before operating

www.dentaldeal.ca

Table of Contents

Introduction

1. Indications for use
2. Contraindications
3. Warnings
4. Precautions
5. Adverse Reactions
6. Step-by-Step Instructions
7. Battery charging
8. Maintenance, cleaning and sterilization
9. Troubleshooting
10. Technical Specifications
11. Symbol and definition

1. Indications for use

Implant Locator is an electronic device used for localization of implants covered by gum tissue during two-stage implantology. The device enables to obtain good results with various implant systems.

2. Contraindications

Implant Locator is not recommended for use in patients or by personnel having a pacemaker or other implanted electrical devices.

3. Warnings

This product must only be used in hospital environments, clinics or dental offices by qualified dental personnel

4. Precautions

4.1. Do not use Implant Locator near devices emitting electromagnetic noise such as fluorescent lamps, film viewers, ultrasonic devices, etc. Cellular phones, remote controls or other devices generating electromagnetic waves may cause abnormal operation of Implant Locator. Such devices should be turned off.

4.2. During device operation protect Implant Locator from occasional spillage of liquids.

4.3. Do not use Implant Locator in presence of flammable materials.

4.4. Implant Locator should be used with the manufacturer's original accessories only.

4.5. In order to prevent infectious agent transmission, the sensor should be changed or sterilized between patients.

4.6. Presence of metallic bodies near the sensor may distort device indication. Avoid presence of metallic items in the vicinity of the sensor during device operation.

4.7. For your own safety, please use personal protection gear (gloves, mask).

5. Adverse Reactions None.

6. Step-by-Step Instructions

6.1. Packaging Box Content

Check the content of the packaging box before use:

Handpiece	1 pcs
Base	1 pcs
Sensor	3 pcs
Sensor Holder	1 pcs
Adapter	1 pcs
Disposable Sleeves	50 pcs

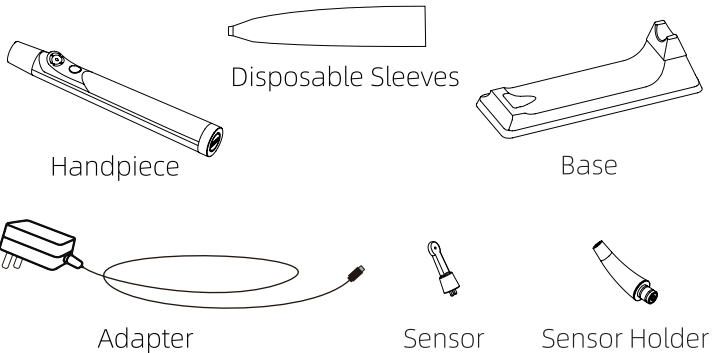

6.2. Implant Locator outlook

General view of Implant Locator is shown on Pic. 1.

Note: Sensor is an Applied Part of the device.

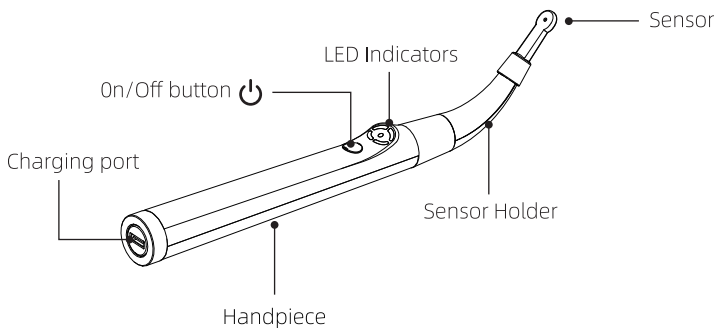

6.3. Getting Started

Prior the first use and between the patients, the device and sensor holder should be cleaned and disinfected using wipes moisturized by disinfectant. The sensor should be cleaned and autoclaved.

6.3.1. Gently attach the sensor holder to the device as shown on Pic. 1.

6.3.2. Insert the sensor into holder until stop as shown Pic. 1.

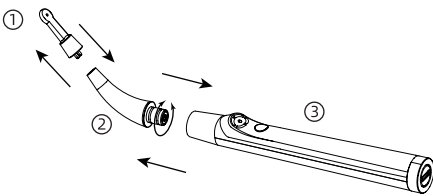

Pic. 1.

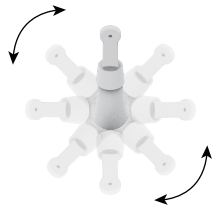

360° rotatable sensor

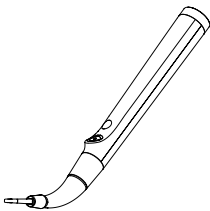

For lower jaw implants

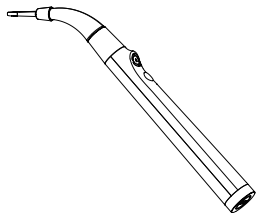

For upper jaw implants

6.3.3. Turn the device on by pressing the button.

 Take care that no metallic object will be closer than 10 cm to the sensor.

6.3.4. Self-test and calibration.

Before starting device operation the self-test is performed.

1. If sensor holder is not properly connected to the device or sensor is not inserted into the holder, the error is indicated by running. red segment After 10 sec. the device turns off automatically.

2. To correct the error, turn the device off, connect the sensor holder, insert the sensor until stop and turn the device on again.

3. After the self-test the device performs automatic calibration.

4. Running green segment indicates calibration in progress. When calibration is completed, 4 segments blink green indicating that the device is ready for operation.

5. Pressing the  button will restart automatic calibration cycle described above.

 **Presence of metallic objects close to the sensor during self-test and calibration may prevent correct device operation or reduce precision of implant local-**

To correct calibration error, turn the device off, check proper connection of the sensor holder and of the sensor. If required, replace the sensor. Verify that there are no metallic objects in the vicinity of the sensor and turn the device on again.

6.4. Device operation

6.4.1. When Implant Locator is ready, 4 segments blink green (Pic. 2).



4 segments flashing green:
self-test and calibration



4 segments blink green: ready

Pic. 2

6.4.2. Insert the device into the mouth cavity and place the sensor plane onto the gum at some distance from the estimated position of the implant. The central hole of the sensor should be approximately in the middle of the jaw ridge. Slowly move the sensor along the jaw towards estimated position of hidden implant.

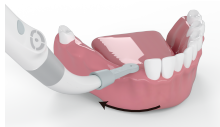

- ⚠ To ensure correct measurements, it is strongly recommended to press  button before each measurement for self-test and calibration.
- ⚠ To ensure correct measurements, take care that the sensor plane will be always slightly pressed to the gum without gap.
- ⚠ Thick gum layer covering the implant may prevent correct implant localization or reduce precision.

⚠ Turning on the device without installing the sensor will cause the device to flash a red light to indicate an error, in which case installing the sensor will cause the device to display an error status or detect inaccurately, and you must press the button once to re-calibrate before using it.

6.4.3. Implant localization

a. When the sensor is approaching the implant, 4 segments turn steady green.

b. Continue fluent movement of the sensor **in the same direction without stopping** until the segments turn orange indicating that the sensor has passed the implant position.

c. **Reverse direction and slowly move the sensor back along the same path.** Four segments turn green again indicating sensor movement towards the implant. Continue sensor movement in reverse direction without stopping.

d. When the sensor returns to the implant position, 4 segments turn off and the central dot turns green indicating detection of implant location. The visual indication is accompanied by “Di-Di” audio signal.

e. Through the hole in the middle of the sensor mark on the gum location of the implant using dental probe.

A

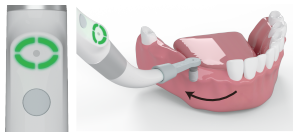

GREEN

Sensor is approaching the implant .

Continue in the same direction Continue in the same direction.

B

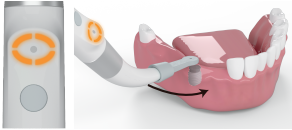

ORANGE

Sensor has passed the implant position.

Reverse direction Continue in the same direction.

C

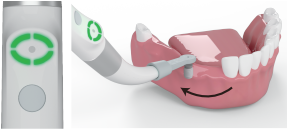

GREEN

Sensor moves back to the implant position.

Continue in the reversed direction position.

Reverse direction Continue in the same direction.

D

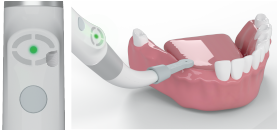

GREEN DOT

Detection of implant location

⚠ The sensor movement should be smooth without stopping or unnecessary reversing the direction of the movement. This may cause incorrect readings.

⚠ Stopping sensor movement for more than 3 sec. before completing detection of implant location is indicated (central green dot turns on) will cause automatic reset (4 segments blink green). Implant localization should be repeated from the beginning.

6.4.4. Cross-scanning

To improve the precision of implant localization it is possible to perform additional cross-scanning in Buccal-Lingual direction.

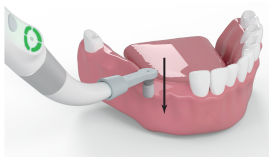

After initial implant localization as shown on Pic. 10d slowly move the sensor in Buccal-Lingual direction pressing it slightly to the gum. The operating sequence is similar to the sequence described in § 6.4.3

⚠️ Presence of metal crown, abutment, tooth with large amalgam filling, metallic instrument close to the implant may prevent correct implant localization or reduce precision.

6.4.5. Localization of multiple implants

In case of multiple implants, after locating and marking the first implant continue to the estimated position of the next implant.

a. Slowly move the sensor along the jaw ridge. The central dot will turn off and 4 segments will turn orange; then the segment will blink green indicating that the Implant Locator is ready for detection of the next implant.

b. Perform implant localization as described in § 6.4.3. and 6.4.4.

⚠️ Correct localization of implant position may be impossible when 2 or more implants are too close.

6.5. Automatic Shutdown

Implant Locator automatically shuts down after 1 minutes without use. In order to prolong the battery life, it is recommended to switch off the device after completing implant localization by pressing the  button and holding it for about 1 sec

7. Battery charging

7.1 When the battery power is too low, the ring light flashes continuously and is displayed in red.

7.2 Connect the adapter to the charging port at the bottom of the handpiece.

7.3 When the battery is charging, the ring light flashes rolling and displayed as orange.

7.4 When fully charged, the ring light light is continuous displayed as green.

7.5 The charging time is about 4 hours.



Battery power is too low
4 segments flashes rolling and displayed as red

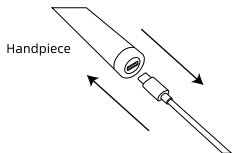

Charging operation



Charging
4 segments flashes rolling and displayed as orange



Charged
4 segments is continuous displayed as green



1. Use only with adapter provided by manufacturer.
2. Using adapters from other brands may cause a fire, explosion, or a damage to the product.
3. The handpiece is unable to use while charging.
4. If the battery drains abnormally quickly, it indicates that the battery life is almost over. In this case, please contact our customer service for a battery exchange.

8. Maintenance, cleaning and sterilization

8.1. General

8.1.1 The device does not contain user serviceable parts. The service and repair should be provided by factory trained service personnel only.

8.1.2 All objects that were in contact with potentially infectious agents should be cleaned and disinfected after each

8.1.3 Use of agents other than specified in this section may cause damage to the equipment and its accessories.

8.2. Device cleaning

Before the first use and between treatments the device should be cleaned using tissue or soft cloth impregnated with aldehyde free disinfecting and detergent solution (a bactericidal and fungicidal).

8.3. Sensor holder cleaning and disinfection

Before the first use and between treatments the sensor holder should be separated from the device, cleaned and disinfected using tissue or soft cloth impregnated with aldehyde free disinfecting and detergent solution (a bactericidal and fungicidal).

- ⚠ No visible impurities should remain on the sensor holder after cleaning and disinfection process.
- ⚠ The sensor is intended for 50 sterilization cycles maximum.

	Operation	Instructions	Details and Warnings
1	Preparation at the point of use prior to processing	No particular requirements	
2	Preparation for decontamination/ preparation before	No particular requirements	
3	Cleaning: Automated	The sensor is not intended for automated cleaning	
4	Cleaning: Manual	Clean the sensor with an adequate brush or towel soaked in a disinfectant solution	After cleaning no visible impurities should remain on the sensor, in particular inside and near the central hole
5	Disinfection	-Soak the sensor in a disinfectant solution combined with proteolytic enzyme if possible - Rinse well the sensor in flowing water	-Follow instructions given by the disinfectant manufacturer (concentration, immersion time, etc.) -Do not use disinfectant solution containing aldehyde, phenol or any products which may damage the items

	Operation	Instructions	Details and Warnings
6	Drying	No particular requirements	
7	Maintenance, inspection and testing of the sensor	Visually inspect the sensor to detect possible damage to the sensor coating or to the gold plating of the contacts and the central hole	-Sensors with damages or scratches on the coating or on the contacts must be discarded -Sensors with damages to the gold plating of the contacts or of the central hole must be discarded
8	Packaging	Pack the sensor in sterilization pouches	-Check the validity period of the pouch given by the manufacturer to determine the shelf life of the sterilized items. -Use packaging which is resistant up to a temperature of 141°C (286°F)
9	sterilization	Steam sterilization at 134°C (273.2F) during 18 minutes in gravity type autoclave. (Table Top, N type)	-Follow maintenance and operation procedures of the autoclave provided by the manufacturer -The only sterilization parameters to be used are those that have been validated and provided to the user in this User Manual
10	Storage	Keep sensors in sterilization packaging in a dry and clean environment	Sterility cannot be guaranteed if packaging is open or damaged (check the packaging before using the sensors)

9. Troubleshooting

Please review the suggested solutions before calling customer service.

	Problem	Possible Cause	Solution
1	The device does not turn on by pressing On/Off button	1. Button malfunction 2.Flat battery 3. Electronic malfunction	1.Press the On/OFF O button several times. 2.Replace the battery 3. Contact your customer service
2	Detect that the sensor is subject to external interference and false alarms	There is metal body interference near the sensor, which affects the detection and positioning accuracy.	Press the on/off button once, restart automatic self-test and calibration. Avoid interference object before using the handpiece again.
3	Press the button does not respond, the 4 segments flashes rolling and displayed as red	The battery power is too low	Charging the battery
4	Device cannot indicate the location of the implant	1. Sensor is disconnected 2. Damage to the Sensor, sensor coating or sensor contacts 3. Sensor holder is damaged; Bad contact 4. Electronic malfunction	1. Turn the device Off, remove the sensor, clean contact surfaces of the sensor and reinsert it. Turn the device On again 2. Replace the Sensor 3. Replace the Sensor holder 4. Contact your customer service

10. Technical Specifications

10.1. Protection type against electrical shock: Class II

10.2. Protection degree against electrical shock: Type B

10.3. Rechargeable lithium battery:

Battery model:14500, Battery capacity: 850mAh

Battery has over-voltage, over current and short circuit protection

10.4. Adapter

Input:100-240V~ 50/60Hz

Output: 5V  1A

10.5. Work condition:Environment temperature: +5°C to +40°C

Relative humidity: 10%~93%

Atmosphere pressure: 70kPa to 106kPa

10.6. Operation Mode : Continuous Operation

11. Symbol and definition

Device marking includes the following standard symbols:



Check the random file



Power on/off, Start button



Type B applied part

IPX0

Ordinary equipment



Date of manufacture



Manufacturer



Class II equipment



Used indoor only



Follow Instructions for Use



Appliance compliance
WEEE directive



Atmospheric pressure for storage



Temperature limitation for storage



Humidity limitation for storage